

**BIG SAVINGS!
Tremendous Variety**

ORDER DIRECT FROM THIS CATALOG

*Satisfaction Guaranteed
or Money Back*

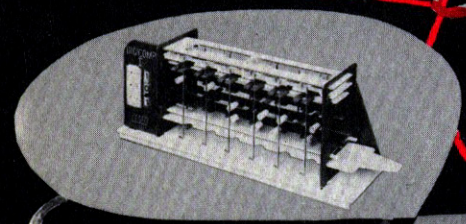

EDMUND SCIENTIFIC CO.

America's Greatest Science • Math • Optics Mart

100 EDSCORP BUILDING

BARRINGTON, NEW JERSEY 08007

609-547-3488

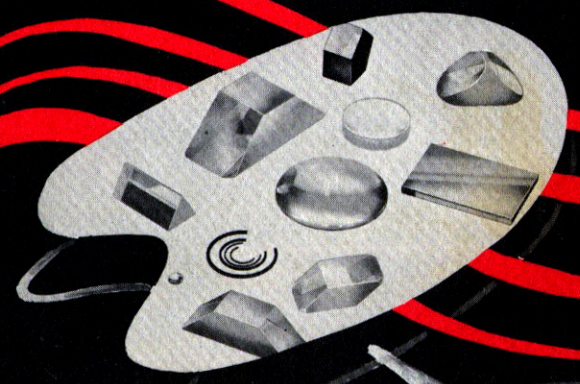

BE SURE TO SAVE
VALUABLE FUTURE REFERENCE

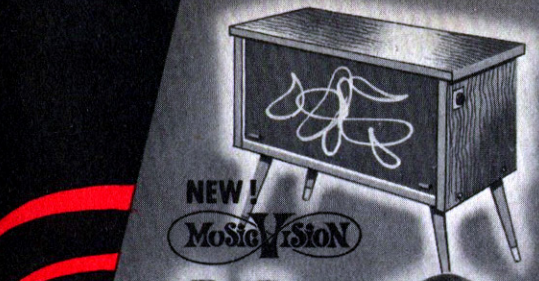

NEW!
Mosic rStion

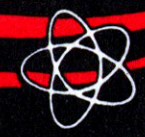
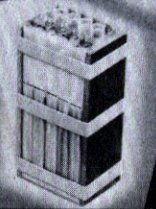
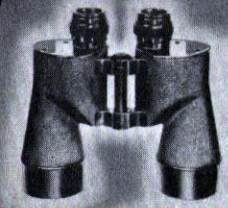

EDMUND

catalog

- SCIENCE
- MATH
- OPTICS

FOR HOBBYISTS
SCHOOLS AND INDUSTRY

**MORE THAN 4000
UNUSUAL BARGAINS**



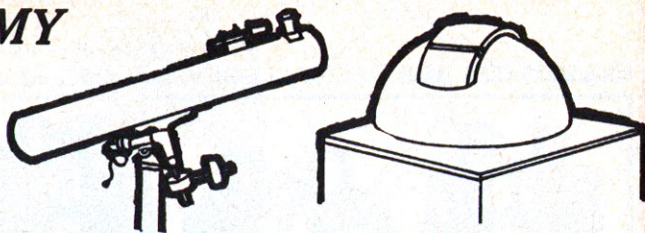

ASTRONOMY FOR FUN, EDUCATION, CAREER



The fascination of astronomy is there for those who have eyes to observe the incredible wonders of the universe. Few people are born who have not, if only for a fleeting moment, wished to know something more about it all. Descriptive books are valuable as far as they go, but their full significance and interest is withheld unless the reader takes the next step of seeing things for himself... with his own or a borrowed astronomical telescope. You will be astonished.

Many amateurs begin their adventures in astronomy at quite an early age with inexpensive telescopes. As their interest grows, they acquire or build larger and more sophisticated instruments. Newspapers frequently report the observation of new comets and other phenomena by amateur astronomers. It is usually the consistent observer who is able to make such important discoveries. Astronomy can also provide valuable background material for a number of space age careers.

A POPULAR HOBBY, FAMILY FUN

Astronomy is a rapidly growing hobby and one popular with all age groups. Observations through a telescope are just as much fun for parents as for children. Each describes and confirms what he has seen and learned. Families take their telescopes with them on vacation to observe areas of the heavens not visible from their hometown. Building a telescope can be a family project, too. If you really want to start from scratch, begin by grinding and polishing your own mirror. Such a hobby can enthuse youngsters for years to come.

There is a great deal more to be learned about the stars, planets and outer space. The serious amateur can still play an important and valuable role. He may wish to specialize in observations of variable stars, meteor pattern detection, or studies of the planets and comets. Your local astronomical society will gladly tell you about the areas where your help is needed. Astro-photography is a fascinating subject and can become an intriguing specialty. Try taking pictures through your telescope. You will be amazed at the results!

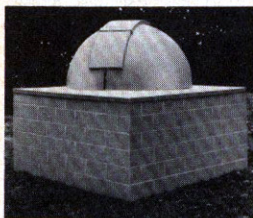

CAREER OPPORTUNITIES IN ASTRONOMY AND AERO-SPACE

Outer space is one of our most important highways to the future, and many young people are giving thought to a career which incorporates some of their interests, such as space exploration. Universities now offer courses in astrophysics, radio-astronomy, planetary and upper atmosphere research, rocket and satellite astronomy. At the moment, the areas of rocketry and guided missiles also offer opportunities—in design, guidance, astro-navigation, electronics, etc.

The National Aerospace Education Council, 616 Shoreham Bldg., 806 15th St. N.W., Washington, D.C. 20005, is a prime source of information on aerospace opportunities. The following pages are jam-packed with information about astronomy, telescopes, and other items that will interest you. Be sure to check pages 141 and 142 for books about astronomy and telescopes.

ESSENTIAL TELESCOPE QUALIFICATIONS

Magnification is usually considered the most important quality of a telescope by beginners. Actually it is just one of the desirable functions. Its use as a sole criteria may be misleading. Light Gathering Power and Resolving Power are two other very important qualities a telescope must have if it is to give the results you desire.

LIGHT GATHERING POWER

Large objectives (in refractors) and mirrors (in reflectors) are used to increase light gathering power from distant objects. This power increases the apparent brightness of an image.

RESOLVING POWER

Resolution is the ability to show fine detail. In an astronomical telescope resolving power depends on the size and quality of the objective or reflecting mirror. The larger the diameter, the greater its ability to show separately two closely adjacent objects such as double stars. You are also able to see object details better.

MAGNIFICATION

Theoretically, there is no limit to the amount of magnification you can obtain. In practice, however, magnification beyond about 60X per inch presents drawbacks. They are: 1) Decreased clarity; 2) Decreased image brightness; 3) Decreased field of view; 4) Vibration amplification and difficult observation of stars which are close together. Telescope experts agree that the top useful power is 50X to 60X per inch of objective aperture; that is, 180X for a 3" telescope, 360X for a 6", etc. No additional detail can be obtained with higher powers. Beyond 50X-60X per inch, everything is amplified including the diffraction patterns, heat waves, dust, clouds and air currents to the point of producing fuzzy images.

Because of this, magnification higher than 60X is useless and misleading. Edmund Scientific Co. attempts to maintain an honest and factual approach to magnification. The listed powers of our telescopes are based on the rule of 60X per inch, not on theoretical and useless power. Every Edmund telescope is guaranteed to be exactly as described or we will refund your money in full.

SELECT THE RIGHT TYPE OF TELESCOPE

There are two basic types of astronomical telescopes; refractors and reflectors. A refractor uses an objective lens and a reflector uses a mirror. The reflector mirror type, because of its economy, seems to be the most popular choice of the beginner.

THE REFRACTOR, OBJECTIVE LENS TYPE

In a refracting telescope an achromatic objective lens gathers the rays of light. At the other end of the tube a primary image is formed. It is this image which is magnified by an eyepiece. Such a lens system is difficult for the amateur to make because it requires accurate alignment, precise color correction and expensive materials. However, once made, it is easy to use since it requires no adjustments except focusing. The closed tube prevents the entrance of dust and moisture. We offer finished optical parts for such a telescope.

THE REFLECTOR, MIRROR TYPE

In a reflecting telescope, the image is "bounced" off a concave, aluminized mirror to a diagonal mirror. This, in turn reflects the image up through the eyepiece. The latter is generally located at the top or front end of the tube.

It is a great deal easier and cheaper for an amateur to grind and polish his own mirror or buy a finished one than it is to make or buy an objective lens of equivalent diameter. Assuming that the quality is good, the ability to resolve fine detail is usually a function of the diameter of the objective lens or mirror. Thus, with a reflecting telescope, you can see **more and better for less money and effort.** You may, of course, wish to do some reading on the art of building a reflector telescope and grinding your own mirror. If so, we suggest you invest in one of the fine books offered in this section.

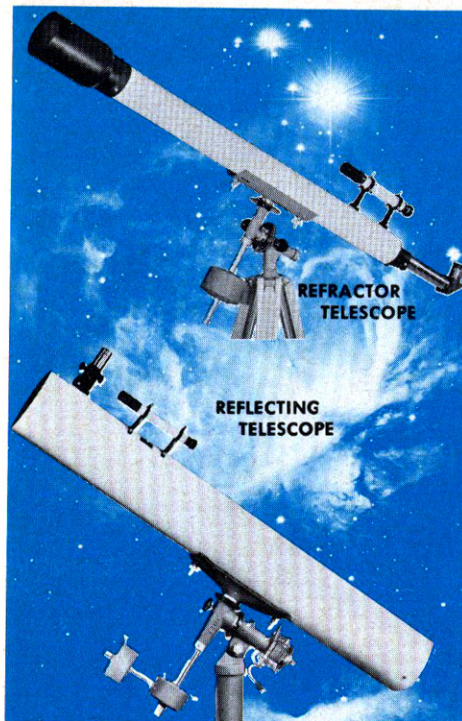

MAKING YOUR OWN TELESCOPE

A close-up of the moon, through a telescope you can make.

Years of working with amateur telescope makers have taught us that making your own reflecting telescope, either by using already finished parts or by grinding and polishing your own mirror is quite practical. With reasonable care an amateur can produce a telescope as good as one purchased at quite a high price.

A good refractor for instance with 4 1/4" objective lens costs about \$250, but you can buy all the finished optical parts to make a powerful 4 1/4" diameter, reflecting telescope for only \$22.75, and you will see as much and as well as you would with the more expensive instrument. Tubes and metal parts can be purchased or made depending on your time and ability. Some amateurs make every part of their telescope including grinding of the mirror. Others, limited in time, buy the completed telescope.

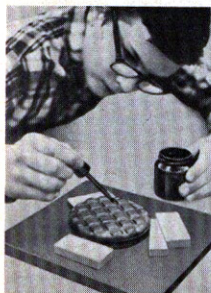

THOUSANDS HAVE FOUND IT EASY

Starting on a small scale about 1925, there has been an ever-increasing group of amateur telescope makers in this country. They grind and polish their own mirrors (usually 6" diameter). They have designed and built instruments capable of following the movement of stars automatically, instruments powerful enough to have discovered new phenomena in the heavens, instruments, in short, that would cost hundreds of dollars if bought ready made. Yet many have been built by men, boys and women with no previous experience or ability! We have had photographs and descriptions of hundreds of telescopes completed by people of all ages and in all walks of life.

You can get started today by looking over our catalog pages and deciding which kit or parts you need. For example, our finished 4 1/4" mirror is priced so low you may want to save time and buy one complete. If, however, you plan to build a 6" reflector, real economies are possible when you grind your own. We supply mirror blanks, grinding and polishing compounds, tools and instructions. See page 127 for outlined suggestions on the building of several fine quality reflectors.

SPACE CONQUEROR 3" REFLECTOR 60X TO 180X



... Only
\$29.95 Ppd.

OUTSTANDING FEATURES

- ★ 3" ALUMINIZED MIRROR
- ★ 3X FINDER TELESCOPE
- ★ 1/2" F.L. EYEPIECE
- ★ BARLOW LENS
- ★ FORK-TYPE EQUATORIAL MOUNT
- ★ LIGHTWEIGHT TUBE
- ★ HARDWOOD TRIPOD
- ★ 1 BOOK, 1 BOOKLET, STAR CHART
- ★ DIRECTIONS

EXCELLENT "FIRST TELESCOPE"

This wonderful telescope is the ideal, low-cost introduction to astronomy and the mysteries of space and the stars. With it you can pursue a fascinating hobby. You can show your children the universe that will play such an important part in their future.

See Saturn's rings, Jupiter's moons, Mars, craters of the moon and the other wonders of the heavens. You will enjoy many hours of educational fun. From a construction standpoint, the Space Conqueror embodies so many features that experienced telescope enthusiasts consider essential for viewing the heavens. You'll have all the magnification power you can use effectively. This telescope is sturdily made, easy to use, and will provide years of enjoyment.

MIRROR . . . HEART OF YOUR TELESCOPE

Since the mirror is the heart of the telescope, it must be of fine optical quality. We are proud of this 3" aluminized, overcoated, 1/4" wave mirror. It has a focal length of 31", f/10, provides true viewing quality, easily aligned by means of three spring tension adjustment screws. Resolving power enables you to observe faint stars separated by as little as 3 seconds of arc. As for light gathering power, this quality mirror permits you to see stars to 10 1/2 magnitude.

3X FINDER . . . LOCATE STARS QUICKLY

Included with the Space Conqueror is a 3X finder telescope to help you quickly locate stars, planets, etc., for observation. See illustration.

60X EYEPIECE

You receive a 1/2" focal length 60X Ramsden eyepiece which provides more than enough magnification for viewing the wonders of the sky. In addition a Barlow lens which, when used with the 60X eyepiece, brings power to 180X, . . . about maximum effective magnification for this size of telescope.

TUBE MOUNT AND TRIPOD

The tube is strong, spiral-wound Kraftboard with an attractive white covering. The inside is dull black to prevent glare and reflections.

Fork-type equatorial mount has a 40° polar axis, a feature not found on other telescopes in this price range. It allows an observer to follow a star's movement with only one movement of the telescope . . . easy to keep the star in view. Tripod sturdily constructed of durable hardwood, 36" high.

Also included, "How To Use Your Telescope" (36 page book); "Handbook of the Heavens" (272 page book); Star Finder; "Star Paths," booklet.

No. 85,050 \$29.95 Postpaid

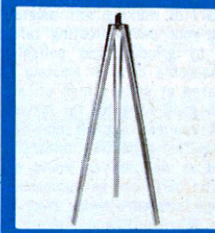
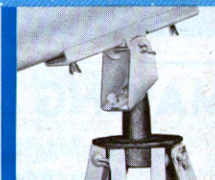

ACCESSORY EYEPIECES

1/4" F.L. gives 120X with Space Conqueror. 320X with Barlow.
No. 30,195 \$3.75 Ppd.

1" F.L. (31X) Excellent for terrestrial or lunar observation.
No. 30,194 \$3.50 Ppd.

3/4" F.L. (41X) War surplus, mounted, symmetrical eyepiece. Fine for wide field viewing and astro photography.
No. 30,315 \$5.95 Ppd.

DELUXE 4 1/4" PALOMAR - TYPE REFLECTOR SPACE CONQUEROR 45X TO 270X

Only **\$84.50**

Transportation
Charges
Collect

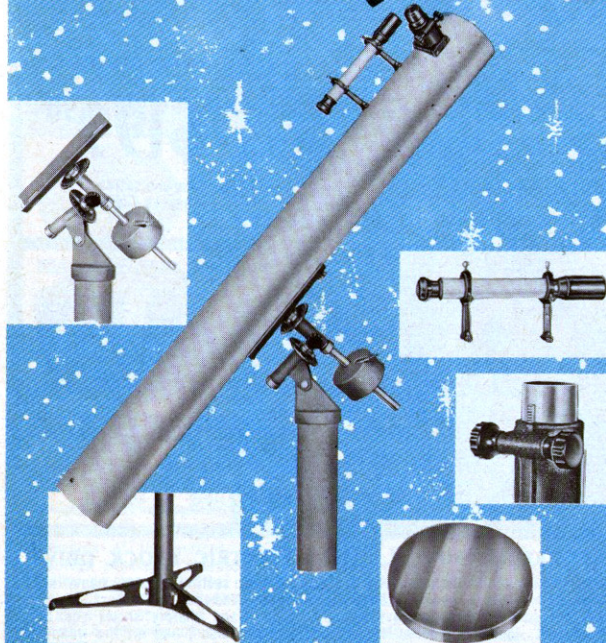

OUTSTANDING FEATURES

- ★ 4 1/4" Spherical Mirror
- ★ 6X Finder Telescope
- ★ Two 1 1/4" Eyepieces
- ★ Rack & Pinion Focusing
- ★ Mounted Barlow Lens
- ★ 46" Aluminum Tube With Beautiful White Finish
- ★ True Equatorial Mount
- ★ 3" Setting Circles
- ★ Counter Balance
- ★ 24" Metal Pedestal
- ★ Full Instructions

COMPARE THE DELUXE SPACE CONQUEROR WITH ANY OTHER MAKE

You'll find it's the ideal telescope for quality-minded beginners and serious amateurs who want the features of ultra-expensive, professional telescopes, but at a bargain price. Schools all across the U.S.A. are buying it for space-age educational programs.

This American-made telescope gives all the power that can be used effectively in a 4 1/4" scope. It's so powerful you can read a newspaper headline 1 mile away! You'll see the moon's craters and seas, Saturn's rings, double stars, Jupiter's moons, etc. And it's easily portable . . . takes only a few minutes to mount.

MANY OUTSTANDING FEATURES

4 1/4" SPHERICAL MIRROR. 45" F.L., f/10. Accurate to 1/4 wave, resolves detail right to the theoretical limit. Pyrex, aluminized, overcoated, and in adjustable mount.

TRUE EQUATORIAL MOUNT. Track the moon, sun and stars with only 1 movement. Adjusts to your latitude. Counterbalanced, two 3" setting circles, ultra-smooth movement, and large locking knobs.

2 EYEPIECES AND BARLOW. We include a 1" F.L., 45X Kellner achromatic eyepiece and a 1/2" F.L., 90X eyepiece, plus a mounted achromatic Barlow lens which doubles and triples the powers of the eyepieces. This gives you all the power you need; 135X, 180X & 270X.

46" LIGHTWEIGHT ALUMINUM TUBE provides a rigid mounting base that lasts a lifetime. Beautiful white finish.

6X FINDER TELESCOPE has achromatic objective with light shade, Ramsden eyepiece in spiral focusing mount, crosshair reticle, adjustable mount.

PEDESTAL BASE. A sturdy, 24" high support of heavy-gauge steel tubing. Reduces wobble and vibration. **FREE BONUS.** "How To Use Your Telescope" (36 pages), "Handbook of the Heavens" (272 pages), Star Finder and "Star Paths". **No. 85,105 \$84.50**

Shpg. wt. 42 lbs. Transp. Chgs. Coll.

DELUXE SPACE CONQUEROR WITH CLOCK DRIVE

As above but with electrical clock drive (pg. 137) added. Shpg. wt. 45 lbs. **No. 85,107 \$134.50 T.C.C.**

IMAGE ERECTOR FOR DELUXE SPACE CONQUEROR

For terrestrial use. 2 fine-quality, coated achromats in chrome-finished brass tube (9 1/2" long) that fits any standard 1 1/4" eyepiece holder. Attach to eyepiece holder, insert eyepiece, and focus. Image is right side up and correct as to right and left. **No. 50,276 \$14.75 Ppd.**

4 1/4" TELESCOPE WITHOUT MOUNT & PEDESTAL

Telescope tube, finder telescope, mirror, mirror mount, eyepieces . . . everything but equatorial mount, cap, and pedestal. Assembled. Shpg. Wt. 10 lbs. **No. 85,113 \$66.00 T.C.C.**

WANT 540 POWER?

This 1/2" F.L. eyepiece gives powers of 180X and 540X when used with Barlow supplied with telescope. **No. 30,204 \$4.75 Ppd.**

SUPER SPACE CONQUEROR

6" REFLECTOR
AMERICAN MADE
COMPLETE LINE OF
ACCESSORIES

48X to
360X



TEFLON BEARINGS,
IMPROVED DRIVE

EDUCATOR ACCEPTED

The Super Space Conqueror is ordered by many, many schools across the country. Completely accepted for purchase under NDEA.

\$199⁵⁰

Transportation
Charges Collect

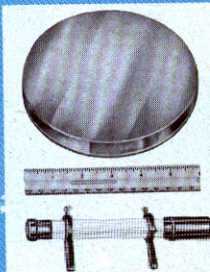

NO EXTRAS TO BUY . . . HAS ELECTRIC CLOCK DRIVE

A superb instrument. It includes electric clock drive, setting circles, heavy-duty equatorial mount and a pedestal base. It fills the demands that most serious amateurs and schools place on a telescope. Clearly and sharply shows you the Rings of Saturn, Jupiter's Moons, Mars, Craters of the Moon, and all the wonders of the sky. It will reveal stars of nearly 13th magnitude and split double stars separated by less than 1 second of arc. Its optical quality and stability have brought us many compliments. Compare it with telescopes costing \$295.00 to \$350.00. The Super Space Conqueror is one of the few telescopes priced to save you money without sacrificing quality. It will give you many years of pleasure.

Pyrex Parabolic Mirror. This fine mirror is hand-finished to 1/4 wave, corrected to the theoretical limit of resolution, aluminized and overcoated. Focal length 48", speed f/8.

6-Power Achromatic Finder Scope with crosshairs; adjustable mount.

Three Standard 1 1/4" Eyepieces and Achromatic Barlow. We include a wide-field achromatic 48X Kellner, a 1/2", 96X and a 3/4", 192X Ramsden and a Barlow that will double and triple each of these magnifications giving you up to 576X. Eyepieces are positioned in a rack and pinion focusing mount.

Sturdy 47 3/4" Long Aluminum Tube. Attractive exterior finish of durable, baked white enamel. Interior is painted a flat black.

Heavy-Duty True Equatorial Mount. New teflon bearings, correctly counter-balanced . . . complete with two 3" setting circles for pinpointing stars.

IMPROVED Electric Clock Drive. New quick clutch with thumbscrew lock for telescope balancing, smoother operation, longer life. Manual slow motion control . . . lever-operated cam adjusts electric drive and permits precise tracking of stars at zenith or horizon. Ideal for long astro photography exposure or group viewing. **Full details on page 137.**

Rigid, All-Metal Pedestal Base is vibration and wobble-free. 24" high.

Included Free. As with every telescope we sell, you get the books and booklets "Handbook of the Heavens," "Star and Satellite Finder," "How to Use Your Telescope" and complete instructions.

No. 85,086 \$199.50

Trans. Chgs. Coll.
(Shpg. Wt. 68 lbs.)

Slow Motion Control Kit for Declination Axis. Allows direct and total correction (within 4°-5°) for astrophotography, etc. Made of aluminum; easy mounting directions incl. (See pg. 137).

No. 60,574 \$18.00 Ppd.

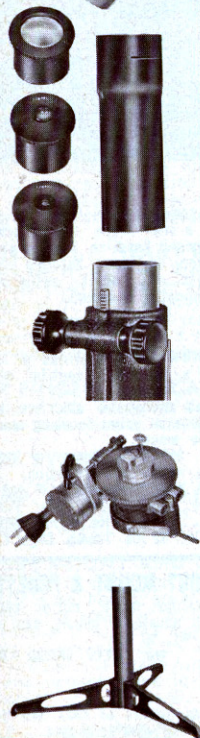

THE 8" REFLECTOR

64X
480X
and
Higher

OUR LARGEST AND BEST
DESIGNED FOR SERIOUS
AMATEURS, COLLEGES,
SCHOOLS



OUT- STANDING FEATURES

- ✓ Hand-corrected (better than 1/4 wave), f/8 parabolic Pyrex mirror with 64" F.L.
- ✓ Three, matched orthoscopic eyepieces
- ✓ Deluxe wide-field 5.5X finder telescope
- ✓ Improved Extra-Heavy-Duty equatorial mount with teflon bearings
- ✓ Now complete with setting circles.

\$389.

Transportation
Charges
Collect

Here is a telescope designed to meet the most exacting requirements of the serious amateur and both school and college astronomy courses. For the most ambitious astronomy programs, studies of galaxies, star clusters, nebula, etc. This 8" reflector offers nearly twice the light gathering power of a 6" and has a resolving power of .6 seconds of arc. The mirror is parabolic, Pyrex, and hand corrected to better than 1/4 wave. It is aluminized and overcoated. Included is a matched set of 4 element, orthoscopic eyepieces (6mm, 12.5mm, and 25mm) precision made and fluoride coated; also achromatic mounted Barlow lens. Although a pedestal base is supplied because of the true massiveness of the telescope a permanent mounting is recommended. The heavy-duty equatorial mount included is designed to mini-

mize vibration. A deluxe, wide-field 5.5X finder scope is provided. Setting circles included. 63" long phenolic tube. Here indeed is a reflecting telescope that will give many years of service. Complete including heavy-duty equatorial mount (described below) and pedestal base, 3 booklets, Star Chart and instructions. Shpg. wt. 206 lbs.

No. 85,143 \$389.00 Trans. Chgs. Coll.
Telescope only (no mount, drive, circles or base). Shpg. wt. 28 lbs.

No. 85,144 \$277.00 Trans. Chgs. Coll.
Telescope, pedestal & mount complete with specially designed clock drive and setting circles (see description below). Shpg. wt. 210 lbs.

No. 85,171 \$464.00 Trans. Chgs. Coll.

EXTRA-HEAVY-DUTY EQUATORIAL MOUNT FOR LARGER TELESCOPES

With clock drive and setting circles (specially designed for 8" telescopes). Function of clock drive similar to one described on page 137, except more sturdily mounted. Setting circles are big 5 3/4" in diameter. Hour circle is actually driven by clock to give more accurate tracking. Slow motion control on clock drive greatly aids locating and holding objects in view. Mount handles any telescope of this size, either of amateur or commercial design. This is not a souped-up 6" mount, but one specifically tailored to handle the massive 8-inchers. It will fit any 6" and even hold 10" reflector models satisfactorily. Handles refractors up to and including the big 5" ones.

Mount has 1 1/2"-diam. polar and declination shafts with 1"-O.D. tip on polar shaft for mounting clock drive. Mount is made of cast iron for greater rigidity where it is most needed. Weighs a full 75 pounds including counterweights. Large teflon bearings reduce friction and permit exact balancing. Specially designed fine adjustment for latitude setting; positive shaft clamping. Mounts on standard 4" pipe. Important: give tube diameter of telescope when ordering. Shpg. wt. 100 lbs.

No. 85,172 \$191.00 Transportation Charges Collect

Mount with setting circles only (no clock drive). Shpg. wt. 95 lbs.

No. 85,134 \$116.50 T.C.C.

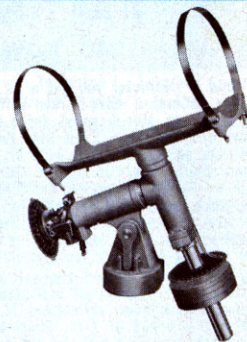

RUGGED PEDESTAL BASE ONLY—AS SUPPLIED WITH TELESCOPE ABOVE

Cast iron post (4" I.D.) with three 2-ft. long feet; 30" high. Cap not incl. Wt. 83 lbs.

No. 85,145 \$32.50 Trans. Chgs. Coll.

8X REFRACTOR TELESCOPE KIT

Excellent for Astronomy Group Projects
Only \$3.00 Ppd.

Every boy or girl of today dreams of taking part in the exploration of outer space. This desire makes building his or her own telescope a real thrill. With this kit even 8 year old children can now build an 8X telescope.

It presents an ideal and attractive group project for scouts, junior astronomy clubs, or similar groups. (Note special quantity prices!) Scope is powerful enough to show craters of the moon, Jupiter's moons, and many stars not visible to the naked eye.

Kit includes objective lens, field lens, eye lens, glare stops, kraftboard tubes, cadmium plated metal ferrules, etc., to make an 18" long, 1 3/4" diameter telescope. Full instructions included.

No. 70,238 Complete Kit only \$3.00 Each Postpaid

Teachers, Scout Leaders, Club Presidents . . . Check these prices

No. P-70,239 Five complete 8X telescope kits \$12.50 Postpaid

No. P-70,240 Ten complete 8X telescope kits 22.50 Postpaid

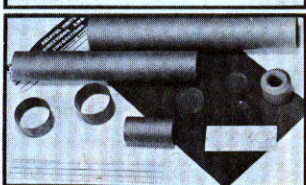
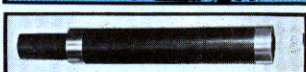

3" REFRACTOR TELESCOPE 45 TO 180 POWER AND HIGHER

See all the wonders of the sky in sharp detail. A few parts imported, but largely American made to precise specifications. Free Star Chart & Star Booklet included. 3", air-spaced, achromatic objective has been tested by famous astronomers and pronounced equal to any you can buy. Low reflection coatings on four surfaces, a 45" F. L., and speed of f/15.

Standard equipment includes 1 1/4" diameter eyepieces . . . one 1/2" F. L., 90X; one 1" F. L., 45X, and a mounted Barlow lens. The latter will double or triple the powers of each of the above eyepieces. This addition gives you extra powers of 135X, 180X and 270X. Eyepiece holder made of aluminum, brass and chrome plated, has a real smooth rack and pinion focusing adjustment. Equatorial mount with counterbalance gives you finger-tip control. Large 1 1/4" diam. knobs operate axis-lock mechanism. Easily adjusted for terrestrial viewing. Tripod legs,



\$125.00

Transportation
Charges
Collect

of natural finish hardwood, are 60" long. 40" main tube is white enameled aluminum with gray wrinkle finish . . . chrome finish on other parts.

Easily-read, precision setting circles, 6X optical finder telescope (with crossline reticle) in a double ring mount and prism star diagonal are included. Shipping Wt. 30 lbs.

No. 85,032 \$125.00 Trans. Chgs. Coll.

4" REFRACTOR

60 to 240 POWER AND HIGHER

With this 4" refractor you get a 6X finder, a sturdy equatorial mount, precision calibrated, easy-to-read setting circles, heavy duty tripod, eyepiece extension, star diagonal, three standard 1 1/4" eyepieces, a mounted Barlow lens, Star Chart and Star Booklet. With the Barlow lens, you can double and triple the powers of each of the eyepieces. This means you can obtain powers as high as 720! Such are fine for experimentation, though we do not recommend them for ordinary viewing.

Everything about this 4" refractor is massive. The mount is built of heavy iron castings with machined bearings for smooth operation. Tripod has extra-heavy, 60", hardwood legs. Weight of entire unit (42 lbs.) allows viewing so steady you wouldn't believe it possible.

The objective is a two element air spaced achromat with elements coated on all four sides to increase transmission and cut down reflection. It has a focal length of 50" and a speed of f/15. Fixed diaphragm stops are built in the telescope tube to cut down stray light.

Three standard 1 1/4" outside diameter eyepieces provide 60X, 120X and 240X. The eyepiece holder has a smooth rack and pinion focusing mechanism with 4 1/2" travel. An eyepiece extension, star diagonal, and Barlow lens are included. The latter doubles and triples the eyepiece powers mentioned above. Beautiful white tube.



\$247.00

Transportation
Charges
Collect

Gray, wrinkle finished, equatorial mount with setting circles is adjustable for all latitudes, has 1 3/4" knobs for positive locking. 6X finder has double ring mount. All metal parts of this fine telescope are plated to prevent rusting. Shipping weight 58 pounds.

No. 85,038 \$247.00 Trans. Chgs. Coll.

Same Telescope with Electric Clock Drive on Mount. Uses 110-volt, AC current. See page 139. Shpg. wt. 60 lbs.

No. 85,087 \$296.50 Trans. Chgs. Coll.

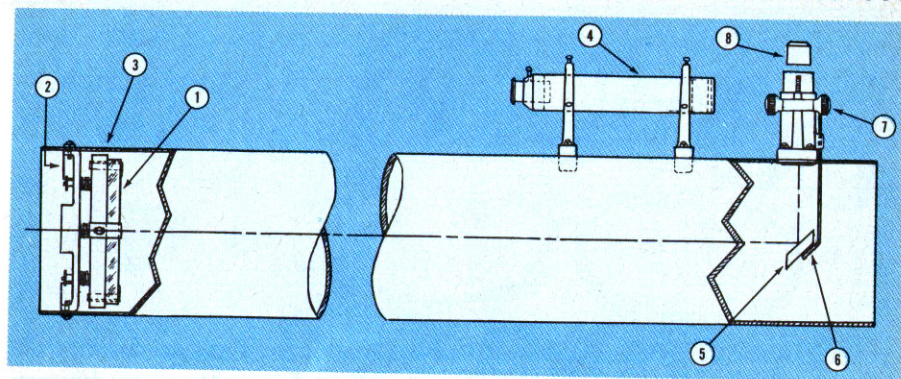

Guide for Building Your Own Reflector Telescope

YOU'LL NEED—1. OBJECTIVE MIRROR

This is the heart of your reflector telescope, so you will naturally want to choose it carefully.

Determine the diameter of mirror you want, such as 3", 4 1/4", 6" etc. Most amateurs make a 6" diameter mirror, although a few start with an 8" size. For mirror grinding kits and blanks see page 128. For finished mirrors and optical kits see page 129.

2. MIRROR MOUNT

This is another important component that should serve as a rigid support, yet be easily adjustable. You can make your own of wood or metal (referring to one of our instruction books on page 142), or purchase one from our own fine selection listed on page 130.

3. TELESCOPE TUBE

This can be of cardboard, wood, aluminum, etc. It should be painted black or "flocked" on the inside to cut bounced light to a minimum, and should have an inside diameter larger than your mirror. For example:

Mirror Size	Tubing Inside Diam.	Mirror Size	Tubing Inside Diam.
4 1/4"	4 7/8"	8"	9"
6"	6 7/8"	10"	12"

See our fine selection of tubing on page 130.

4. FINDER TELESCOPE

You use a 3X to 8X finder to locate the object you want to observe with your high-powered telescope. We have many fine-quality, inexpensive, war surplus lenses which you can use to make one of these. Or, you can buy one complete. See page 131.

5. DIAGONAL MIRROR OR PRISM

This directs the light rays of the image from the objective mirror into the eyepiece. It should be optically flat, aluminized and overcoated. Here, as with the objective mirror, the better ones are those polished to 1/4 or 1/8 wave accuracy. It is easier to buy than to make. See our own assortment on page 130.

6. DIAGONAL MIRROR OR PRISM HOLDER

We have inexpensive holders, also a fine quality brass holder which adapts to tubes from 5" to 9" I. D. and is adjustable. See our selection on page 130.

7. EYEPIECE FOCUSING HOLDER

This may be a simple sliding type or a rack and pinion focusing mount. See ours on page 130.

8. EYEPIECES . . . THEY MAGNIFY THE IMAGE

Usually eyepieces consists of two or more mounted lenses. A holder (draw tube or rack & pinion) focuses the image in the eyepiece. Quality is determined by make (Orthoscopic, Kellner, etc.), focal length (27mm, 40mm, etc.) and apparent field of view (50° 40°, etc.) See pages 132-134 for our fine selection of each type.

9. TRIPOD AND MOUNT (Not Illustrated)

You can make either or both of these. We list tripods and a wide selection of mounts (altazimuth and equatorial . . . simple or complex), pages 138-139.

10. INSTRUCTION BOOKS See pgs. 134, 142

Four of the best are Thompson's, Texereau's, Ingalls' and Brown's "All About Telescopes."

SUGGESTED PARTS LISTS

All of these stock numbers are listed with prices in the Astronomical Section of this catalog

TELESCOPE PART	6" REFLECTING TELESCOPE	4 1/4" REFLECTING TELESCOPE	3" REFLECTING TELESCOPE
Image Erector	No. 50,276	No. 50,276	
Eyepiece Holder	No. 50,077 or No. 60,067	No. 50,077 or No. 60,067	No. 60,067
Diagonal Holder	No. 60,049 or No. 50,025	No. 60,035 or No. 50,025	No. 60,035 or No. 40,276
Diagonal Mirror	No. 30,188	No. 30,260	No. 30,259
Mirror Mount	No. 50,117	No. 50,079	No. 50,109
Tube (not drilled or painted)	No. 85,008 or No. 85,014 (for 48" to 54" F. L. mirrors)	No. 85,013 or No. 80,038	No. 80,056
Mounts and Tripods	No. 85,023	No. 85,023 or No. 85,009	
Mirror Kit	No. 70,004	No. 70,003	
Finished Mirror	No. 5002	No. 50,051	No. 50,082

Choose your eyepieces, finder, etc., from our wide selection listed on the following pages.
"Edmund has the Accessories to Improve Your Present Telescope Too"

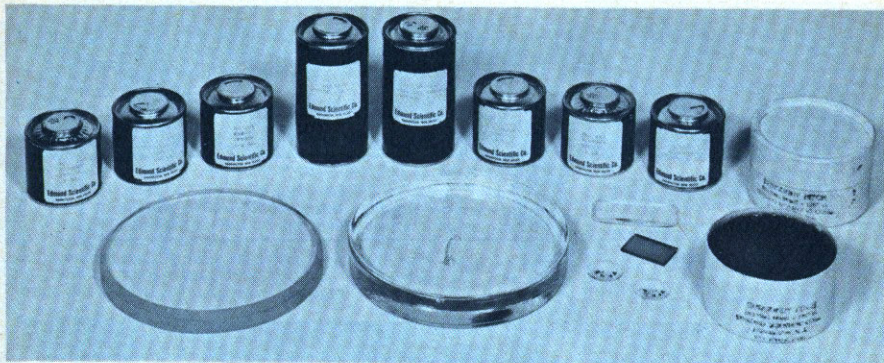

COMPLETE MIRROR GRINDING AND POLISHING KITS . . . INCLUDE BLANK, TOOL AND ABRASIVES

The ultimate thrill for the amateur telescope maker is grinding his own mirror. It is a project requiring patience, but one that pays off in much satisfaction and a real saving in money.

Our kits make mirror grinding easy! Each kit contains a Pyrex mirror blank in the size listed, and plate glass tool used to grind the mirror; 2 lenses which only require mounting to give you an excellent 1" F. L. eyepiece; a first surface rectangular mirror diagonal for alignment and set up; a magnifying lens for inspection.

We also supply 8 assorted abrasives from coarse to fine in shaker top containers, and tempered Burgundy pitch. We do not supply instructions, because successful results require detailed directions which can be found

only in books on the subject. Mirror blanks in fine-annealed Pyrex. No. 7740.

Stock No.	Dia. Mirror	Thick.	Shpg. Wt.	Kit Price
70,003	4 1/4"	3/4"		\$ 8.00 Ppd.
70,004	6"	1"		13.95 Ppd.
70,005	8"	1 3/8"		21.00 Ppd.
70,006	10"	1 3/4"	30 lbs.	34.25 *T.C.C.
70,007	12 1/2"	2 1/8"	46 lbs.	65.85 *T.C.C.

*Transportation Charges Collect

See "Homebuilt Telescopes," Page 142 . . . best book yet on mirror grinding for the amateur.

QUALITY* ANNEALED PYREX NO. 7740 MIRROR BLANKS

PLATE GLASS GRINDING TOOLS

Diam.	No.	Price	Thick	No.	Price	Thick
3"				40,037	\$1.25	3/8"
4 1/4"	80,016	\$3.25	3/4"	80,011	2.00	5/8"
6"	80,017	6.00	1"	80,012	3.50	5/8"
8"	80,009	10.00	1 3/8"	80,013	5.75	3/4"
10"	80,000	21.00	1 3/4"	80,014	12.00	7/8"

Items above shipped postpaid. The 3" and 4 1/4" tools can be used as mirror blanks if desired. Items below shipped Railway Express, Transportation Charges Collect.

12 1/2" 80,010 \$36.50 2 1/8" 80,015 \$16.00 1 1/8" Shpg. wt. 21 lbs. Shpg. wt. 14 lbs.

Annealing strain birefringence: 10 mu/cm of light path.

TEMPERED BURGUNDY PITCH

For making "pitch lap." A real trouble saver because no rosin or beeswax need be added. Big 1/2 pound container. **No. 40,023 Only 80c Postpaid**

OPTICAL BLACK & WHITE PAINTS

New suede-finish enamels in 6-oz. spray cans for primed metal or wood. Black makes perfect light absorbing and diffusing surface for interiors of telescopes, cameras and other optical equipment, darkrooms, etc. White uniformly scatters incident light from any angle.

Black. **No. 60,608 \$2.75 Ppd.**
White. **No. 60,609 \$2.75 Ppd.**

"ALL ABOUT TELESCOPES" by Sam Brown
The newest book on the subject. Excellent for amateurs and for advanced enthusiasts. See page 142.

RUBBER PITCH LAP MAT TIME SAVING WONDER

Avoid all those disappointing break-outs of the pitch, common when hand cutting the channels. Pour the melted pitch on the tool, lay mat on top then press it in with your mirror to form channels. When pitch sets, an easy pull will remove the mat. In minutes instead of hours you are set to polish.

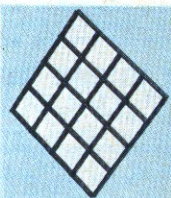

No.	Size	For Mirror	Price
50,171	13 1/2 x 13 1/2"	8", 10", 12"	\$2.50 Ppd.
60,061	6" x 6"	4 1/4", 6"	1.15 Ppd.

Template For Grinding 6", f/8 Mirror. Also sighting ring & collimating directions. **No. 40,316 50c Ppd.**

ABRASIVES . . . IN SHAKER TOP CONTAINERS FOR MIRROR GRINDING OR INDUSTRIAL USE

Now! Abrasives in small quantities. The abrasives listed below, range from coarse to extra fine and should be used in the order listed. All are guaranteed free from contamination. Shakers help you to evenly distribute abrasive and reduce waste . . . last 4 for fast polishing.

Stock No.	Description	Quantity	Price, Ppd.
40,022	#80 Alundum	16 oz.	\$1.25
40,021	#120 Alundum	6 oz.	.80
40,020	#220 Alundum	4 oz.	.80
40,019	#320 Alundum	3 oz.	.80
40,018	#400 Alundum	3 oz.	.80
40,017	#600 Alundum	2 oz.	.60
40,016	#305 Emery	2 oz.	.60
40,015	Red Jewelers Rouge	8 oz.	1.00
40,152	Cerium Oxide	4 oz.	1.50
40,153	Cerium Oxide	8 oz.	2.75
40,158	Barnesite	4 oz.	1.60
40,159	Barnesite	8 oz.	2.80

OPTICAL KITS FOR REFLECTOR TELESCOPES . . . WITH COMPLETED MIRRORS



Forget the grinding if you like . . . these kits have all the optics you'll need

Make your own precision reflecting telescope with these kits containing a finished mirror, eyepiece lenses, diagonal and complete instructions. Kits do not include tubes, mounts, etc. You'll find tubes listed on page 130, mounts, tripods, clock drives on pages 138-139.

3" MIRROR TELESCOPE OPTICS KIT

All the optical parts you need to make a powerful, astronomical reflector telescope: (1) 3" diameter mirror, 30" F.L., ground and polished to 1/4 wave length, aluminized and overcoated with silicon monoxide. (2) First surface, aluminized, diagonal mirror (1/2" x 3/4") (3) Two, plano-convex lenses to make a 1" F.L. Ramsden eyepiece. Gives 31X, and this can be greatly increased by purchasing shorter F.L. eyepieces or a Barlow lens. Directions for spacing, mounting, etc. Instructions incl.

No. 50,081 \$9.95 Postpaid

4 1/4" MIRROR TELESCOPE OPTICS KIT (Illustrated)

Same parts as above except 4 1/4" Pyrex mirror included has 45" F.L., is ground and polished to 1/4 wave length, aluminized and overcoated with silicon monoxide. Gives 45X which can be greatly increased by purchasing shorter F.L. eyepieces or a Barlow lens. Aluminized diagonal mirror measures 25mm x 35mm. Instructions included.

No. 50,074 \$22.75 Postpaid

FIND SKY OBJECTS EASILY

A set of 8"-diameter setting circles that help you find sky objects easily . . . just dial the proper numbers in R.A. and Dec. These 1/4"-thick phenolic setting circles have easy-to-read white markings on a black background. 1/4" diameter center holes.

The Right Ascension Circle has 3 scales, 0-24 hour scale, hour angle scale 0-6-0, and sidereal hour angle scale 0-360° of arc. Declination Circle 0° to ± 90°. Set of 2 with instr. **No. 50,133 \$3.00 Ppd.**

5 1/4"-diam. Setting Circle Set **No. 50,190 \$2.50 Ppd.**

DELUXE ALUMINUM SETTING CIRCLE SET

4" diameter, smoothly finished aluminum 1/4" thick. Edge engraved and filled with black. 1"-diam. center holes. Can be enlarged to fit your telescope. Complete with locking set screws, 4 brass pointers, 2 adjustable pointer clamps, and booklet "Time in Astronomy". Right Ascension scale: 1-24 hours, hour angle scale 0-6-0. Declination scale: 0-360°

No. 50,246 \$18.00 Ppd.

2 1/4"-diam. Set. As above, but with center holes to fit our 8" reflector telescope mounts (Nos. 85,143 and 85,134 only). **No. 60,221 \$18.00 Ppd.**

See Equatorial Mounts, Pedestal Bases and Tripods, Electric Clock Drives listed on pages 138 and 139.

ASTRONOMICAL TELESCOPE MIRRORS

Polished, aluminized and overcoated. 1/4 wave or better.*

No.	Diam.	F.L.	Thickness	Price
40,913	2 1/2"	25"	3/8"	\$4.00 Ppd.
50,082*	3"	30"	3/8"	7.65 Ppd.
50,051*	4 1/4"	45" Pyrex	3/8"	21.00 Ppd.
71,026*	6"	60" Pyrex	1"	90.00 Ppd.

Parabolic Pyrex Mirrors

No.	Diam.	F.L.	Thick.	Shpg. wt. lbs.	Price
5002	6"	48"	1"		\$59.50 Ppd.
85,069	8"	64"	1 3/8"	5.5	89.00*
85,070	10"	80"	1 3/4"	11	179.00*
85,071	12 1/2"	100"	2 1/8"	21	275.00*

*Transportation Charges Collect

PRESSURE-SENSITIVE FLOCK PAPER . . . EASY TO APPLY, KILLS REFLECTIONS

Flock-Stick paper with pressure sensitive back is the ideal material for lining telescope tubes. Just peel off backing and apply. Whether you are building your own telescope or would like to improve the performance of the one you own, Flock-Stick will do the job—quickly. Black, velvet-like non reflecting surface provides millions of light traps and makes this material far superior to flat, black paint. In 20" x 30" sheets.

Single sheet **No. 70,621 \$2.00 Ppd.**

Pkg. of 50 sheets. **No. P-70,622 \$70.00 Ppd.**

Non-Adhesive 27" x 36" sheet. **No. 60,068 \$1.00 Ppd.**

See Jet-Black, Light Absorbing Fabric on Page 72. Excellent for lining optical instruments.

RACK & PINION

HELICAL GEAR SHAFT AND KNOBS



Far superior to straight rack and pinion. Big advantage is smoothness of operation. Steel shaft and helical gear are in one piece. Brass bushings included. 14 teeth per in., face 236", Pressure angle 14 1/2" Pitch 14, Shaft diam. .177", Length 2 3/8". Gear O.D. .275"

No. 40,197 \$1.50 Ppd.

BRASS HELICAL RACK. Meshes with gear above.

No. 40,196 Length 3 3/8" \$1.25 Ppd.

No. 40,195 Length 1 1/4" 2.50 Ppd.

RACK & GEAR FOCUSING MECHANISMS

Spur gears have 1/8" face, pressure angle of 14 1/2° and a pitch of 48. Other specifications in table below.

BRASS SPUR GEARS

BRASS RACKS

No.	O.D.	Hole Size	Teeth	Price Ppd.	No.	Size	Price Ppd.
40,055	1/4"	3/32"	10	\$1.35	40,060	4"	\$1.00
40,056	1/8"	1/8"	12	1.35	40,054	6"	1.50
40,057	2/64"	1/8"	14	1.35	40,053	12"	2.65
40,058	3/8"	1/8"	16	1.35			
40,059	2/64"	1/8"	18	1.35			

STAR TIME CALCULATOR

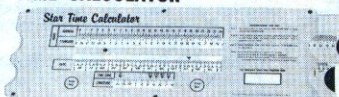

This handy slide rule automatically makes the conversion from star or sidereal time to standard time. Saves the amateur astronomer time and many mathematical calculations. Attractive, plastic-coated cardboard rule measures 10 3/8 x 3 1/8". **No. 40,399 \$1.50 Postpaid**

BASIC PARTS FOR BUILDING ASTRONOMICAL REFLECTOR TELESCOPES

GOOD QUALITY MIRROR MOUNTS

3" An excellent low-cost mount. Unassembled, with directions. Outer diam. 3 1/2". Fits our No. 80,056 cardboard tube or No. 85,012 aluminum. Shims not included. **No. 50,109 \$2.95 Postpaid**

4 1/4" Adjusting clamps act on mount alone. Metal clips hold mirror to mount. 3-point suspension. Mount O. D. 4 7/8". Fits our No. 85,013 alum. tubing, can be shimmed for No. 80,038 tube. Unassembled, with directions. **No. 50,079 \$3.95 Postpaid**

6" Cast aluminum. Completely assembled. Metal clips hold mirror firmly. Outer diameter of mount is 6 13/16". Fits tubing No. 85,014 alum. or No. 85,008 cardboard. **No. 50,117 \$7.50 Postpaid**

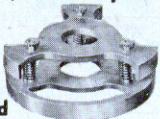

8" Cast aluminum, assembled. Metal clips to hold mirror. O. D. 9". With shims (not included) will fit our tubing No. 85,139 cardboard or No. 85,146. **No. 70,072 \$10.50 Postpaid**

DELUXE QUALITY MIRROR MOUNTS

Cast aluminum flotation cells support mirror at 9 points. Positive collimation lock. Primed and painted black. **No. 70,537 (For 10", 12" O.D.) \$39.50 Ppd.**
No. 70,538 (For 12 1/2", 15" O.D.) 48.50 Ppd.

QUALITY ELLIPTICAL MIRROR DIAGONALS

1/4 wave for 6" telescopes

These are ground and polished to 1/4 wave length, aluminized and overcoated. Just the right size for an F/8, 6" diameter telescope using normal focal length eyepieces. Size: major axis 1 3/4", minor axis, 1 1/4". Thickness 3/8". **No. 30,188 \$3.75 Postpaid**



1/2 WAVE FOR 6" TELESCOPES

Same size as 1/4 wave mirror above, but ground and polished to 1/2 wave length, aluminized and overcoated. **No. 30,205 \$5.00 Postpaid**

LARGE SIZE TO 1/4 WAVE LENGTH

Size needed when eyepieces with 1 1/2" F. L. or longer are used. For use with an f/8, 6" diameter mirror, or 8" diameter mirrors with normal focal length eyepieces. Size: 1 1/2" minor axis, 2 1/8" major axis. Thickness 3/8". **No. 30,258 \$5.75 Postpaid**

OTHER SIZES TO 1/4 WAVE OR BETTER

No. 30,259 (7/8 x 1 3/4" x 3/8" thick for 3" scope) \$3.50
No. 30,260 (1 1/16 x 1 1/2" x 1/4" thick for 4 1/4" scope) 3.75
No. 30,261 (1 7/8 x 2 1/2" x 3/8" thick for 8", 10" scopes). 12.00
No. 41,131 (2 1/4" x 3 1/2" x 3/8" thick for 10", 12" scopes) \$19.50

MIRROR DIAGONALS AND MOUNTS

For 4 1/4" telescope. Aluminized and overcoated mirror. Cemented to 4 3/4" rod and holder. Mirror face measures 2 5/8 x 3 4/16". **No. 60,086 \$3.00 Postpaid**

For 3" telescope. Cemented to angle bracket. Mirror face 2 1 x 2 9/16". **No. 60,087 \$2.25 Ppd.**

SPIDER MOUNT FOR REFLECTING TELESCOPE

This versatile brass, 4-legged spider mount is adaptable to telescope tubes from 5" to 9" I. D. Takes mirror or prism. Plate is mounted on exact 45° angle, measured 1 1/2" x 2". It is adjustable with set screw. Complete instructions included. **No. 50,025 \$4.25 Postpaid**

TELESCOPE MOUNT

Fits tubes to 5 1/4" in diam., and any photographic tripod. Zinc-coated metal. Top piece 6 1/2" x 2". **No. 30,180 \$4.50 Ppd.**

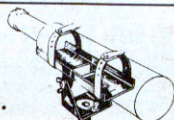

EYEPIECE MOUNTS

1 1/4" RACK AND PINION ONLY \$9.00

A real rack and pinion focusing mount at an amazingly low price. Takes standard 1 1/4" eyepieces. Micrometer-smooth focusing action, travel 2 1/4". Two focusing knobs, variable tension. Four mounting holes for greater rigidity, nuts and bolts included. Black wrinkle finish cast aluminum. Chrome tube. Diagonal holder not incl.

No. 50,077 \$9.00 Ppd.

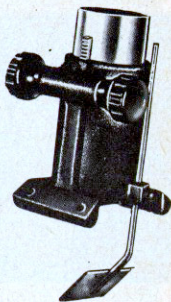

DIAGONAL HOLDERS

No. 60,035 For 3" to 4 1/4" telescopes **\$1.00 Ppd.**
No. 60,049 For 6" telescopes **\$1.00 Ppd.**

STANDARD 1 1/4" SLIDE FOCUS

Here is an economical eyepiece and diagonal holder made of plastic. The unit includes 3" long chrome plated focusing sleeve also locking screw for diagonal. Diagonal holder in illustration is extra and not included.

Diagonal holders listed above fit this holder, and we suggest those. **No. 60,067 \$2.50 Postpaid**

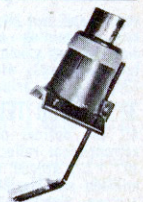

TELESCOPE TUBING . . . ALL SIZES

No.	I. D.	O. D.	Lgth.	Description	Wt. Lbs.	Price
80,056	3 7/8"	3 3/4"	32"	Spiral paper	*1 1/2	\$2.25
80,038	4 7/8"	5 1/4"	46"	Spiral paper	*6	3.80
80,081	1 7/8"	2"	48"	Aluminum	*3	4.00
85,008	6 7/8"	7 3/8"	60"	Spiral paper	**10	4.00
85,011	2 7/8"	3"	48"	Aluminum	+5	6.00
85,012	3 7/8"	4"	60"	Aluminum	+6	8.75
85,013	4 7/8"	5"	46"	Aluminum	+6	9.00
85,014	6 7/8"	7"	60"	Aluminum	+22	15.00
85,139	9"	9 3/4"	72"	Spiral paper	+22	13.50
85,146	9 1/4"	9 1/2"	63"	Phenolic	+10	30.00

(*Postpaid in U.S.A. only.) (**T.C.C., requires Railway Express sht. Charges can be up to \$8.00 depending upon distance. Check with your local office.) (†Trans. Chgs. Coll.)

TELESCOPING CARDBOARD TUBES

Sturdy Kraft with blackened inside. Each nests into next one. Wall thicknesses 1/16" to 1/4". I. D.'s: 1/2", 5/8", 3/4", 7/8", 1", 1 1/4", 1 1/2", 1 3/4", 2", 2 1/4", 2 1/2", 3".

Twelve 3-ft. pieces. **No. 80,042 \$8.00 Ppd.**
Twelve 18" pieces. **No. 60,501 4.50 Ppd.**
Twelve 9" pieces. **No. 60,502 2.50 Ppd.**

BLACKENED BRASS EYEPIECE TUBING

The three diameters listed will give you a slide fit when used together. Use them as eyepiece, focusing tube and holder respectively. (See retaining rings on page 98).

Stock No.	Length	I. D.	O. D.	Price, Ppd.
117	3"	1 3/16"	1 1/4"	\$1.80
118	2"	1 1/4"	1 5/16"	1.50
40,161	3"	1 5/16"	1 3/8"	1.80

ADJUSTABLE CLAMPS

Fine stainless steel hose clamps perfect for connecting 3 1/2" to 4 1/2"-diam. tubing. Cut and bolt to handle other sizes. Pkg. of 2. **No. P-50,604 \$1.25 Ppd.**



TELESCOPE FINDERS

7-POWER FINDER

This 7X finder has 30mm diam. coated achromatic objective, Ramsden eyepiece, glass cross line reticle. Measures 8" long x 1 1/2" O. D., weighs 8 oz. Tube is black anodized aluminum. Slide focusing eyepiece mount has locking screw. 7X Finder without Mount **No. 50,080 \$9.95 Ppd.**



FINDER RING MOUNTS ILLUSTRATED ABOVE

Lightweight rings measures 2" I. D. Each has 3 thumb screws for adjusting finder. Cast aluminum construction. Supplied complete with nuts and bolts for mounting on any size telescope.

No. 50,075 Per Pair \$3.95 Postpaid

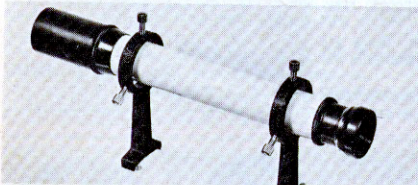

EDMUND 6X FINDER TELESCOPE

A low-cost, good quality finder complete with adjustable ring mounts. Telescope is white enameled aluminum, has coated optics, spiral focusing achromatic objective with lightshade. A Ramsden eyepiece (thread focusing) includes wire crosslines. Mount is cast aluminum with wrinkle finish and will fit any size telescope. Clear aperture of objective 23mm. Length approximately 9". Weighs less than 8 oz. **No. 50,121 \$9.00 Postpaid**

6X DELUXE FINDER

This deluxe finder is a very impressive accessory. The telescope with glass crossline reticle is similar to finder on our \$389, 8" reflector (pg. 125). The objective, 50mm diam., offers excellent light gathering power. Wide-angle eyepiece gives exceptionally large field. Twin ring mount, described below, has three adjusting screws for each ring. You can always remove finder for use as a Ritchey-Field telescope and easily recenter it. Can be mounted on any diameter telescope. Complete with mount. **No. 70,175 \$32.50 Postpaid**

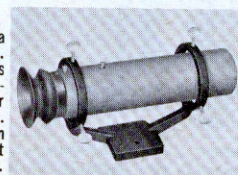

SINGLE BASE TWO-RING MOUNT

Same as supplied on Deluxe Finder above. Unit is all in one piece. Takes up to 2 3/4" O. D. tube. Each ring measuring 2 7/8" I. D., has 3 adjusting screws. Overall length is 6 1/2", height 5". Cast aluminum, black wrinkle finish. **No. 70,079 \$9.95 Postpaid**

LOW COST

3X FINDER

(Now supplied on 3" Space Conqueror)

Has 31mm objective lens (PCX 31 x 152) in spiral-wound Kraft tube with slide-focus eyepiece. Measures 8 1/2" long x 1 1/4" outside diameter. Complete finder.

No. 60,363 \$3.00 Postpaid

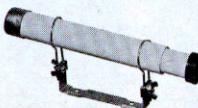

7X RIGHT ANGLE FINDER GIVES COMFORTABLE SIGHTING



More comfortable and convenient to use than the straight finder scope. Can be mounted close to the telescope eyepiece for fast shifting of eye from finder to telescope. 30mm diam. achromatic objective, Ramsden eyepiece, glass crossline reticle. Black, anodized aluminum tube measures 8" long x 1 1/2" O. D. Eyepiece is slide focusing with set screw for locking in place. (Our ring mounts **No. 50,075, \$3.95** per pair, are the correct size for this finder.) **No. 50,249 \$11.50 Postpaid.**

TELESCOPE LIGHTING UNIT

Helps preserve your night vision. Fasten to tripod leg. Two 39" cords, each with grain of wheat lamp and housing. One lamp is controlled for brightness by a rheostat for illuminating crosshairs. The other cord and lamp can be used to illuminate setting circles, eyepieces, charts, etc. Takes "D" battery (not incl.). **No. 50,219 \$2.95 Ppd.**

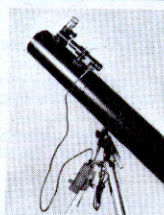

RUBBER EYEGUARDS



Excellent war surplus rubber eyeguards for many optical instruments. Will stretch slightly for fitting. Styles vary from illustration.

Hole Diam.	Ht.	Stock No.	Price Ppd.
1 1/2"	2 1/4"	60,099	\$1.00
1 3/8"	1 3/4"	40,258	1.00
1-18"	1 1/4"	60,100	1.00
1 1/8-1 1/8"	1"	40,967	1.00

1X RIFLESCOPE . . . EASILY CONVERTS TO 8X

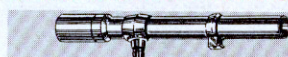

SALE

Complete illustrated directions included for converting to 3X without changing the lenses or up to 8X using lenses that can be purchased from us. Has military reticle. Length 8 7/8", diameter 7/8".

No. 50,032 New, not coated. \$4.95 Ppd.
No. 50,031 Used, not coated. \$3.95 Ppd.

EDMUND STAR FINDER

• Easy Way to Explore Skies

No previous knowledge of constellations or accurate knowledge of time, location or direction factors, is necessary to locate and identify any charted visible star with our precision-made metal instrument. Aim at an unknown star and locate it on the star map that is included. Any part of the sky can be examined—no blind spots.

The view is erect, same size, same brightness. Has full adjustment for use anywhere in the U.S. or Canada. Use it with a telescope to locate double stars, clusters and nebula. Can also be used for study of elementary celestial navigation or surveying.

Two large, easy-to-read dials enable you to get the finder on target according to the hour angle and the angle of declination. Overall size is 8" x 4" x 7 1/4". Designed for use on any tripod or simple mount.

No. 70,501 \$9.00 Ppd.

EYEPIECES... THEIR DESIGN, FUNCTION AND USE

Selecting the best eyepiece for your telescope is an important project. The ratio of the focal length of the objective to that of the eyepiece determines the power. The purpose of the eyepiece is to magnify the primary image formed of some distant object by the objective or mirror. The image rays, as they travel through the eyepiece system, are compressed into an almost parallel bundle. Field of view is also determined in part by the eyepiece.

- (A) **Symmetrical.** Two identical achromats spaced a small distance apart.
- (B) **Concave Lens.** Used in Galilean telescopes. Only type that gives erect image. Good only for extremely low power. Very narrow field of view. Single simple lens.
- (C) **Ramsden.** Two plano-convex or double-convex lenses. Economical type. Real image formed in front of field lens. Field 35° to 45°. Two simple lenses.
- (D) **Orthoscopic.** Triplet field lens and simple plano-convex eye lens. Excellent color correction and wide field . . . 35° to 50°. Found only on very expensive scopes.
- (E) **Huygenian.** Note image plane falls between lenses. Better color correction than the Ramsden. Excellent for microscopes and telescopes. Field 25° to 40°.
- (F) **Kellner.** Achromatized Ramsden for better color correction. There are several variations of this type. Field 40° to 55°. The most popular type for telescopes.
- (G) **Erflle.** An eyepiece especially designed for extra-wide field with good correction of all aberrations. Field from 65° to 70°. Usually quite expensive.

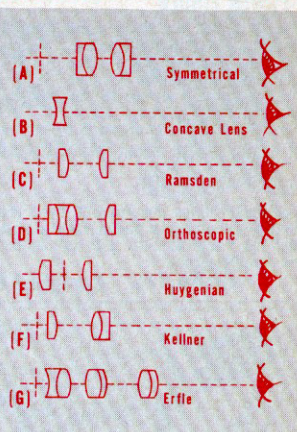

COMPLETE SELECTION ORTHOSCOPIC EYEPIECES

- Wide Flat Field
- Best Correction At High Magnification
- Excellent Eye Relief
- Coated Optics



Because of its triplet the Orthoscopic eyepiece is one of the most important and best corrected eyepieces. The most popular choice for high-powered astronomical viewing. It offers a tremendously wide, flat field; excellent correction (both spherical and chromatic); freedom from ghosts and scattered light; and greater eye relief than even the Kellner. These precision made Orthoscopic Eyepieces are of a four-element design with fluoride coated lenses. They have standard 1 1/4" outside diameter measurements. Chrome plated brass and aluminum mounts.

Effective Focal Length	Power given with 48" F. L. Objective	Stock Number	Price Ppd.
4mm	300 Power	30,364	\$17.00
6mm	200 Power	30,404	14.50
12.5mm	96 Power	30,405	14.50
18mm	67 Power	30,406	19.00
25mm	48 Power	30,407	14.50

KELLNER EYEPIECES

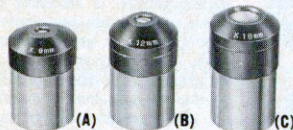

- Wide, flat fields
- Excellent correction
- Good eye relief
- Coated

These brand new, imported Kellners are eyepieces you'll be proud to own and show your astronomer friends. Excellent color correction. All have standard 1 1/4" outside diameter and 50° apparent field of view. Ample eye relief. Modern design features attractive chrome and black finish with easily visible markings.

Eyepiece	Focal Length	Eye Lens Diam.	Field Lens Diam.	Stock No.	Price, Ppd.
(A)	9mm	5mm	7.5mm	60,492	\$9.75
(B)	12mm	7mm	8 mm	60,493	9.25
(C)	18mm	15mm	19 mm	60,494	9.00

20MM-F. L. ERFLE

- Excellent spherical and chromatic correction
- Very wide, flat field
- Excellent eye relief
- Coated lenses

An eyepiece you'll use more than any you own. Extremely wide 65° field of view and excellent correction of all aberrations.

This precision made, imported Erflle will give you good power for use with refractors, reflectors, rich field telescopes, finder scopes, spotting scopes, etc. Standard 1 1/4" outside diameter. Coated lenses, excellent eye relief. Diameter of eye lens 22mm, field lens 26mm. Streamlined, modern design with handsome chrome and black finish.

No. 60,495 \$24.00 Ppd.



WIDE ANGLE EYEPIECES—KELLNER & ERFLLE

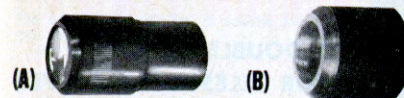

(A) **28MM-F.L. KELLNER IN STANDARD 1 1/4" MOUNT.** This large field (50°) precision-built, war surplus eyepiece with slightly over 1" focal length is best for normal telescope viewing. Big focal lens and long eye relief make it very easy to find objects. Proven military eyepiece design features 2 achromatically corrected lenses of highest quality (field lens 30mm, eye lens 28mm) in black anodized aluminum cell.

No. 5223 \$9.95 Ppd.

(B) **24.5MM-F.L. WIDE ANGLE ERFLLE EYEPIECE** This versatile eyepiece is particularly suited for use in low power telescopes, spotting scopes or binoculars. Lens has 5 elements . . . 2 achromats and a single positive. Optics made by B&L for wide-angle binocular. Black, anodized aluminum mount, 1 1/4" long x 1 3/4" in diameter.

No. 60,225 \$12.00 Postpaid
Unmounted lenses only, with spacing directions.

No. 60,214 \$6.00 Postpaid

RAMSDENS—MOUNTED IN ALUMINUM BARRELS



Standard 1 1/4" outside diameter. We mounted two excellent quality, plano-convex lenses in black anodized aluminum barrels instead of chrome-plated brass to save you money, to kill reflections and to give a clear image. Directions included for using short focal length eyepieces.

6mm Focal Length. No. 30,204 \$4.75 Ppd.
12.7mm Focal Length. No. 30,203 4.50 Ppd.

As above, but 0.917" outside diameter. Type used in our own 3" telescope "The Space Conqueror."

6mm Focal Length. No. 30,195 \$3.75 Ppd.
12.7mm Focal Length. No. 30,198 3.75 Ppd.

25.4mm Focal Length. No. 30,194 3.50 Ppd.
With Etched-Glass Crossline Reticle. Similar to 25.4mm-F. L. eyepiece directly above O. D. 0.917".

No. 30,334 \$6.95 Ppd.

RAMSDEN EYEPIECE SETS—UNMOUNTED

Sets contain two plano-convex or double-convex lenses. Mount them in a short length of tubing (see page 130) for eyepieces of various powers. Some lenses may have chipped edges or small scratches, but all are guaranteed to be perfectly usable. Spacing directions included.

No.	Approx. F. L.	Price Ppd.	No.	Approx. F. L.	Price Ppd.
30,208	6mm	\$1.75	5198	19mm	\$1.00
30,210	12.7mm	1.50	5195	25.4mm	1.00
5198	12.7mm	1.00	5191	38mm	1.00

ZOOM EYEPIECE

\$26.50 Ppd.



- Does the work of 3 or 4 eyepieces—eliminates lost time and refocusing!
- True zoom . . . stays sharp at all powers!

One of the handiest astronomy accessories to come along in years. Unlike pseudo "zoom" optics, this eyepiece needs to be focused only once; subject stays in focus whether you're at 8.4mm or 21mm focal length. Standard 1 1/4" O.D. Fully orthoscopic coated lenses give wide flat field. Excellent correction for both spherical and chromatic aberrations. To find the minimum and maximum magnification with your scope, divide objective focal length by 8.4mm and 21mm respectively. Typical magnifications are 50 to 120X (can be increased 2 to 3 times with Barlow). Excellent eyepiece for special laboratory instruments. No. 60,362 \$26.50 Ppd.

Reduced Price . . . Mounted, Wide-Angle Kellner Eyepiece Was \$13.50 . . . Now Only \$8.50

This fine, war surplus eyepiece has 2 coated achromats. Ideal for a rich field telescope or a wide angle finder scope. 70° field of view, 42 mm. focal length, O.D. of barrel 29 1/16", clear diam. of field lens 17 1/8", clear diam. of eye lens 1 1/16". No. 60,234 \$8.50 Ppd.

19MM—F. L. SYMMETRICAL EYEPIECES

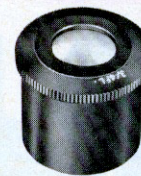

This fine eyepiece in standard 1 1/4" diam. aluminum mount contains 2 coated achromatic lenses. Clear diameter of lenses 16mm.

No. 30,316 \$6.95 Ppd.

In 0.917" diam. Mount. Similar to above, but with standard microscope size mount. Two coated achromats. Focal length 19mm.

No. 30,315 \$5.95 Ppd.

6MM HUYGENIAN EYEPIECE

Terrific buy on best quality Japanese-made eyepiece. Mount is standard 1 1/4" O. D. chrome-plated brass. Directions for using short F. L. eyepiece included. 6mm Focal Length. No. 30,063 \$5.00 Ppd.

STANDARD EYEPIECE ADAPTER

Change your substandard eyepiece to standard size 1 1/4" O. D. Adapter is fastened with small set screw. I. D. 0.917". Black, anodized aluminum.

No. 30,199 \$1.95 Ppd.

NEW! YOUR OWN WEATHERPROOF OBSERVATORY WITH EDMUNDS TELESCOPE DOME AND ADAPTER BASE

A "no-carry" telescope location for advanced amateurs, astronomical societies, schools, etc. Ends distractions from wind, lights, noises and curious onlookers. Supplied in 8 easily-handled parts of sturdy, maintenance-free fiberglass, the Edmunds Astronomical Dome assembles easily and quickly within a few hours. Mount it over a skylight, atop your garage roof or any home-built 8 ft. square opening (scaled plans incl.). Dome has 6 ft. diam. x 3 ft. high interior; accommodates telescopes up to 6 ft. long. Gives plenty of clearance at zenith. 360° hand rotation on low-friction nylon wheels and guides. Light green exterior blends with surrounding landscape; darker green interior. 18" wide x 57" long center opening has 2 watertight divided covers. Dome, adapter base and hardware shipped in 2 crates. Total gross weight 320 lbs.

No. 19,097 \$595.00 F.O.B. Conn.

For more details and descriptive literature, write to our Sales Engineering Dept.



INSTEAD OF THIS

SEE THIS

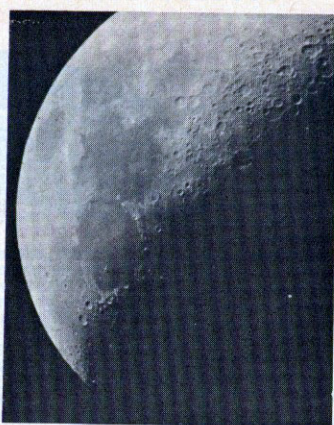

BARLOW LENSES TO DOUBLE OR TRIPLE YOUR TELESCOPE'S POWER



A Barlow lens is designed to double or triple the magnification of a telescope with but a very slight increase in focal length. One of the most practical accessories you can buy, it eliminates the need for hard-to-use, short focal length eyepieces or long, cumbersome telescope tubes. By narrowing the cone of light, it often improves the performance of eyepieces . . . particularly those of Huygens or Ramsden type. It is a negative lens and is placed in the eyepiece tube.

ORIGINAL GOODWIN, ACHROMATIC, COATED BARLOW LENS—Only \$23.50 Ppd.



This high quality lens has been unavailable for years, but we can now offer it made to the original specifications. The Goodwin Barlow is as optically perfect as precision craftsmen can make it. The cemented, two-element achromat is especially made for it. It has an effective F.L. of 44mm. (—1.73" or approx. —1.94"). The coated achromat is mounted in

a cell held by spring tension inside a 4" long blackened adapter tube. The tube accepts standard 1 1/4" eyepieces. The position of the achromat inside the tube can be easily changed to fit the characteristics of individual telescopes . . . one of the important features of the Goodwin. Thus you can use it with almost any telescope. Complete with instructions.

No. 60,122 \$23.50 Ppd.

COLOR-CORRECTED, 2-ELEMENT BARLOW LENS

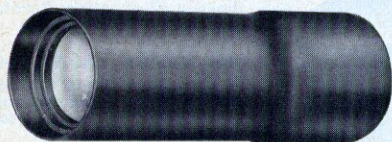

You will enjoy your telescope more with our color-corrected, two-element, mounted Barlow. Position of Barlow lens element can be changed in mount to vary power. It doubles or triples the power and provides increased eye relief—focal length is 46.6mm. Brass mount, gloss black outside, dull black inside, slides into 1 1/4" inside diam. draw tubes. It also accepts 1 1/4" standard eyepieces.

No. 40,477 \$8.00 Ppd.

Lens only from above, ready for mounting.

No. 30,448 \$3.00 Ppd.



BARLOW FOR YOUR JAPANESE TELESCOPE

Mounted Barlow (.965" outside diam.). Instead of 60X, you get 120 to 180 power. Graphically the illustration at top of page shows approximately what you can accomplish. Mounted in two pieces of telescoping brass tubing, each 4" long. Satin-chrome plated finish. Standard size for most Japanese telescopes, but measure your eyepieces before ordering (.965" is approx. 31/32" or 24.5mm).

No. 30,370 \$6.00 Postpaid

"DICTIONARY OF ASTRONOMICAL TERMS"

Over 1700 definitions of important terms, theories, symbols and men in astronomy. Paperbound, 265 pages (4" x 7")

No. 9373 \$1.75 Ppd.

3-POWER, ADJUSTABLE DIAMETER BARLOW

Fits where other Barlows won't! This adjustable-diameter model has prongs on metal mount that can be opened or closed to fit eyepiece tubes with from 1 1/4" to 1" inside diameter. Installation directions included.

No. 30,339 \$5.00 Ppd.



NEW! FOUCAULT TESTER KIT

Now, you can easily assemble your own Foucault knife-edge tester with this inexpensive kit. When completed, use it to test spherical mirrors, for parabolizing mirrors, checking effects of different mirror-polishing strokes, etc. We use one in our laboratory. Kit includes every part you need: 7.5-watt bulb and socket, knife-edge, wire, cord and plug, slide, 5" x 5" wooden base, 6" column, cap, spacer, hardware and complete assembly and usage instructions.

No. 70,977 \$5.95 Ppd.

See Schlieren System for studying the change in the Index of Refraction of air, page 97.

EXPLORE THE MAKEUP OF THE STARS WITH EDMUND'S STAR SPECTROSCOPE



Consider star spectroscopy. The spectrum derived from a star's light can be used to determine its temperature, chemical composition, and speed of rotation. The Edmund Star Spectroscope can introduce you to this fascinating subject. It is designed for visual spectroscopy and has 3 cylindrical lenses, one each for first, second and third magnitude stars. It consists of a train of five prisms of crown and flint glass, plus lenses. Fits standard 1 1/4" telescope eyepieces.

No. 50,023 \$45.00 Ppd.

HIGH-QUALITY, LOW-COST OBJECTIVES for REFRACTORS

The cost of a refractor is usually much higher than a reflector. Our high-quality parts at bargain prices help you cut the initial costs.

YOU'LL BE PLEASED WITH THESE LENSES

ACHROMATIC OBJECTIVES

Because the objective lens is the heart of every refractor a good one is essential. These imported achromats are air spaced to give the lens system four surfaces (all have low reflection coatings) on which aberrations can be corrected. They produce clear, sharp, color-free images (to the C & F lines) and are also free from coma and spherical aberrations. Ideal for visual use, they are also excellent for photographic work provided a yellow filter is added. Each lens is mounted in a black metal cell with threaded retaining rings. Cells will fit our standard aluminum tubing.



Diameter	F.L.	O.D.	I.D.	No.	Price, Ppd.
3"	45"	3 1/8"	3"	50,162	\$51.00
4"	60"	4 1/8"	4"	70,128	89.00
5"	71"	*	5"	*70,164	150.00

* Mounted in cell with 5 1/2" O.D., 6 1/2" flange. With adapter for mounting in 6 7/8" I.D. tubing.

UNMOUNTED, AIR-SPACED, ACHROMATIC OBJECTIVES

Diameter	Focal Length	Stock No.	Price, Ppd.
3"	45"	30,190	\$41.00
4"	60"	50,107	69.00
5"	71"	70,163	125.00
6"	90"	70,383	195.00

LOW-COST 50" F.L. ACHROMATIC LENS

Build a low-cost refracting telescope with this 50" F.L. lens that will give 100 power using a 1/2" F.L. eyepiece. 2" diam. low-reflection coated achromat is air-spaced. Plans for several telescopes you can make with this objective are in our booklet, "Telescopes You Can Build", p. 142. See our Barlow lenses on p. 134 for increasing the power of your telescope.

No. 30,187 \$12.50 Ppd.

MOUNTED, WAR SURPLUS ACHROMAT

Mounted in brass cell with retaining ring. Clear aperture 35mm; F. L. 178mm. Used with eyepiece No. 30,194 (\$3.50) and mounted porro prism No. 50,187 (\$4.50) this quality achromatic lens makes excellent 7X terrestrial scope.

No. 40,429 \$1.50 Postpaid

LOW-COST ACHROMATIC OBJECTIVES MEET BEGINNERS' BUDGET

To solve the problem of good quality low-cost objectives for a beginner's telescope, we have had these achromatic lenses designed and mass produced. They are excellent! Diameter 32mm (1 1/4"), F. L. 31". You get 62X with 1/2", 124X with 1/4" eyepiece.

No. 30,201 \$3.50 Postpaid

Diameter 42mm (1 3/4"), focal length 41". You get 41X with 1" eyepiece; 82X with 1/2"; and 164X with 1/4". Airspaced.

No. 30,202 \$7.95 Postpaid

ACCESSORIES FOR REFRACTOR TELESCOPES



(A) EYEPIECE MOUNTS

Mount has smooth rack and pinion focusing with variable tension adjustment. Tube accommodates standard 1 1/4" diam. eyepieces and accessory equipment. Lightweight, aluminum body. Focusing tube and rack of chrome-plated brass. Body has black wrinkle finish. Focusing excursion is of 4 5/8" for viewing close or distant objects with any objective. Clear aperture measures 1 1/4".

No. 50,103 For tubes 2 7/8" I.D. **\$13.50 Ppd.**
No. 50,108 For Tubes 3 7/8" I.D. **\$14.50 Ppd.**

(B) PRISM STAR DIAGONAL

Use with refractors equipped with standard 1 1/4" O.D. eyepieces when viewing stars overhead or at Zenith. You can also adapt this diagonal to accept sub-standard diam. eyepiece tubes. Has high quality right-angle prism. Tubes are chrome-plated brass. Sturdily-built, lightweight body is black, cast aluminum with wrinkle finish. Optical path of system measures approx. 3 1/2". Clear aperture of prism is 7/8".

No. 70,077 \$12.00 Ppd.

(C) FIRST SURFACE MIRROR STAR DIAGONAL

Low-cost accessory for comfortable viewing with refractor telescope. Can also be used on standard microscopes. Eyepiece end accepts eyepieces with O.D. of 0.917". Plastic, with first surface mirror. Clear aperture is 3/4".

No. 30,278 \$3.00 Ppd.

(D) AMICI PRISM ERECTING SYSTEM

Gives right angle viewing with an erect image that is also correct from right to left. Adds to comfort when viewing terrestrial objects. Takes standard 1 1/4" O.D. eyepieces. Sturdy chrome and black wrinkle finish. Clear aperture of prism is 7/8".

No. 50,247 \$12.00 Ppd.

(E) TELESCOPE PRISM ERECTING SYSTEM

Porro-prism system, similar to binocular erecting system gives erect image viewing. Fits all refractor telescopes with standard 1 1/4" O.D. eyepieces. Chrome-plated brass tubing and black wrinkle cast aluminum housing. Optical length of system 8". Clear aperture 1 1/4".

No. 70,078 \$12.50 Ppd.

(F) Revolving Turret for Telescope Eyepiece

"Dial in" three different eyepiece powers by just revolving turret. Equipped with an indent which correctly positions each of the eyepieces in the field of view. Accepts 3 standard 1 1/4" O.D. eyepieces. Will attach to refractor telescope with eyepiece tube measuring 1 1/4" I.D. Aluminum and brass with chrome-plated eyepiece tubes. Clear aperture 1 1/4".

No. 50,355 \$14.50 Ppd.

FOLLOW STARS EASILY WITH EDMUND

EQUATORIAL TELESCOPE MOUNTS

VALUE OF AN EQUATORIAL MOUNT

An equatorial mount makes it easy for you to follow stars, moon, planets as they move across the sky. It is equipped with both polar and declination axes at right angles to each other. You point the polar axis at the North Star and fix it there. The telescope is then moved about the declination axis to find the star or object you wish to follow. Slight rotation of your telescope on the polar axis will keep the object constantly in view as it moves across the heavens. Better still, add a clock drive to do the tracking for you.

SETTING CIRCLES SUPPLIED ON ALL MOUNTS

Finding objects in the sky is made so much easier with the fine setting circles included on all mounts on this page.

6" EQUATORIAL MOUNT ON PEDESTAL BASE

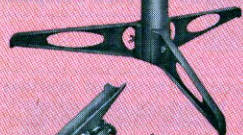

6" EQUATORIAL MOUNT ON TRIPOD

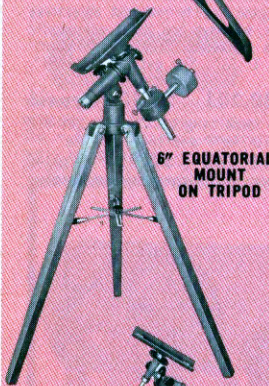

4 1/4" EQUATORIAL MOUNT ON PEDESTAL BASE

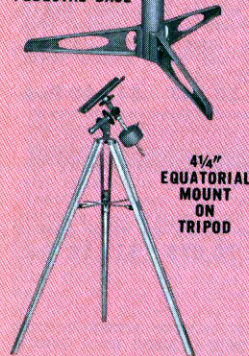

4 1/4" EQUATORIAL MOUNT ON TRIPOD

6" REFLECTOR EQUATORIAL MOUNTS (Teflon Bearings) WITH AND WITHOUT CLOCK DRIVES

Same fine mounts with teflon bearings, setting circles and clock drives used on our 6" Reflector (page 124). Also excellent for 4" and smaller refractors. 2-axis balancing allows for additional equipment anywhere along scope.

- (A) Sturdy design to eliminate vibrations.
- (B) Precision teflon bearings for smooth operation.
- (C) Variable polar axis for altitude adjustment.
- (D) 12" cradle holds 3" to 10"-diameter tubes.
- (E) Big friction holding knobs on both declination and polar axes.
- (F) Pleasing gray wrinkle finish.
- (G) 30"-high Pedestal of heavy gage, 3" steel tubing, 3-toed base.
- (H) Tripods made from kiln dried hardwood.
- (I) Setting circles included.

Clock Drive, Heavy-Duty Mount, Pedestal.

No. 85,111 Shpg. wt. 48 lbs. \$94.50

Heavy-Duty Mount, Pedestal.

No. 85,108 Shpg. wt. 46 lbs. 45.00

For Refractors—Wooden Tripods

Heavy-Duty Mount, Clock Drive, 60" Tripod.

No. 85,082 Shpg. wt. 42 lbs. \$98.50

Heavy-Duty Mount, 60" Tripod.

No. 85,034 Shpg. wt. 40 lbs. 49.00

For Refractors—Wooden Tripods

Heavy-Duty Mount, 32" Tripod.

No. 85,023 Shpg. wt. 36 lbs. \$39.50

SEE SLOW MOTION CONTROL KIT FOR DECLINATION AXIS—Pg. 137

4 1/4" REFLECTOR EQUATORIAL MOUNTS (Teflon Bearings) WITH OR WITHOUT CLOCK DRIVE

Same fine drive and mount used on our 4 1/4" reflector. Excellent for up to 3" refractors. Clock drive is described on page 137. Mounted on the same sturdy pedestal base as our heavy-duty equatorial mount, or on 40" and 60" tripod legs, or without legs. While not as rugged as the heavy-duty above, you will find this unit will give you lots of pleasure by eliminating continual adjustment. Ideal for the amateur who wants a real clock drive, equatorial mount and sturdy pedestal base or tripod at a minimum cost. Setting circles incl.

Med.-Duty Mount, Clock Drive, Pedestal.

No. 85,112 Shpg. wt. 35 lbs. \$73.50

Med.-Duty Mount on Pedestal.

No. 85,109 Shpg. wt. 33 lbs. 24.00

Med.-Duty Mount, 40" Tripod.

No. 85,009 Shpg. wt. 18 lbs. 18.95

Med.-Duty Mount, 60" Tripod.

No. 85,015 Shpg. wt. 20 lbs. 22.50

8-INCH, EXTRA-HEAVY-DUTY EQUATORIAL MOUNT . . . SEE PAGE 125

IMPORTANT NOTE: TRANSPORTATION CHARGES COLLECT ON all items listed on this page.

Track Stars Effortlessly!

IMPROVED ELECTRIC CLOCK DRIVE

- New Slow Motion Control—sensitive, manual compensating lever for more precise tracking with or without electricity; plus better photos
- New Quick Clutch—balance scope in seconds
- More accurate—properly mounted on polar shaft only
- Accepts low-cost, clock driven setting circle
- High quality 1/15 RPM motor

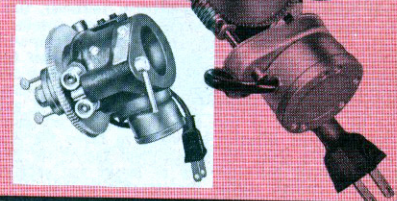

Once a star is located, the drive takes over and keeps it in the field for any normal viewing period.

SLOW MOTION CONTROL corrects for even the minute variation (less than 4 min./day) of the clock itself from true sidereal time. Lever operates sensitive cam which moves whole clock assembly and adds cam's correction to uniform drive rate of clock.

Friction-type **QUICK CLUTCH** releases quickly with thumbscrews for initial balancing only. Clutch then allows you to move scope quickly without damaging drive.

Motor and large 3" pitch diameter, 96-tooth, hardened aluminum gear and ground and polished steel worm give smooth performance with great torque. Factory assembled for precision, easily installed in minutes.

Same drive supplied with mounts on opposite page. Adaptable to almost any mount by fitting to polar shaft. Supplied with housing clamp with either 1" or 1 1/2" hole (this clamp with pin takes the reaction to the drive and serves also as the slow motion compensator). Operates on 110-volt, 60-cycle AC current. Instructions included.

Clock Drive (fits 3/8" shaft and 1" housing). May be bored out to fit shafts from 5/8" to 1". Fits our telescope mounts Nos.: 85,105; 85,009; 85,109; 85,015; 70,257.

No. 70,726 \$49.50 Ppd.

Clock Drive (fits 1" shaft and 1 1/2" housing). Fits our telescope mounts Nos.: 85,034; 85,108; 85,084; 85,023.

No. 70,725 \$49.50 Ppd.

Clock Drive (bored to fit polar shaft of later model Edmund 8" telescope mounts with shaft end turned down to 1" O.D.)

No. 70,788 \$62.50 Ppd.

CLOCK-DRIVEN RIGHT ASCENSION CIRCLE. Mounts directly on clock drives 70,725; 70,726; 70,788 to provide sidereal time and eliminate calculation of star positions. Stays true to moving star pattern without your having to correct it. Black phenolic circle, 5 1/4" in diam., with pointer and mounting hardware. Hour and degree scales. 1 1/4" center hole. **No. 60,569 \$9.00 Ppd.**

MANUAL SLOW MOTION CONTROL KIT FOR DECLINATION AXIS. Holds star within any desired 4° to 5° declination. Similar to slow motion control on clock drive. Includes declination shaft block with eccentric pin and manual tracking compensating lever. Fits scopes 85,086 & 85,087; mounts 85,082 & 85,081, or homemade mounts with 1" shaft and 1 1/2" declination shaft housing. Black and cadmium finished aluminum. 3 1/2" x 2" x 2 1/2". Instructions. **No. 60,574 \$18.00 Ppd.**

MOTOR FOR CLOCK DRIVE. Synchronous-type electric motor operates on 110-V, AC, 60-cycle. Output shaft rotates counter-clockwise at 1/15 RPM. Output torque 60 in.-oz. 3/8"-diam. shaft, 2 1/4" long. Two mounting holes. 6" leads. Overall size (excluding shaft) 2 1/8" x 1 3/8" x 2 3/8". **No. 50,199 \$7.50 Ppd.**

MATCHING WORM AND WHEEL SET. When used with electric motor your telescope will follow the stars. 3" pitch diameter, 32 pitch, 96 teeth, 3/2" face, .375" diam. bore. Plain, solid brass gear. No hubs or webs on wheel. Steel worm has .1875" diam. bore. **No. 30,307 \$12.00 Ppd.**



OPERATE CLOCK DRIVE ANYWHERE
This small inverter supplies 110V, 60 cycle electricity from your car battery. Can also be used to operate electric shaver. 15 watt rating. Size 2 1/2" x 2 1/2" x 4". Weight 2 lbs. For 12-V battery only. **No. 50,346 \$19.25 Ppd.**

EQUATORIAL MOUNTS FOR 6" & 4 1/4" SCOPES

Same as mounts described on opposite page, but without tripod or pedestal, 6" scope has new 2-axis balancing system. With setting circles.

For 6" Telescopes. Heavy duty.

With clock drive. **No. 85,083 Shpg. wt. 32 lbs. \$84.00 T.C.C.**

Without drive. **No. 85,084 Shpg. wt. 34 lbs. \$34.50 T.C.C.**

For 4 1/4" Telescopes. Medium duty.

Without drive. **No. 70,257 Shpg. wt. 14 lbs. \$17.50 T.C.C.**

Post Cap. For mounts above.

For 6", heavy duty mount. **No. 40,771 \$4.00 Ppd.**

For 4 1/4", medium duty mount. **No. 40,772 \$4.00 Ppd.**

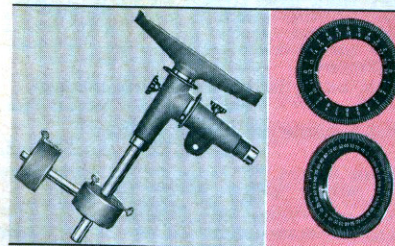

PEDESTALS For 6" & 4 1/4" Scopes

Sturdy, three-toed, 24"-high pedestal base for Heavy Duty Mounts No. 85,084; 85,083. Mounts bolt to 3/8" hole in top cap (can be enlarged to accept other mounts). Heavy-gage, steel tubing; gray wrinkle finish. Shipped Transportation Charges Coll.

No. 85,142 Fits our 6". Shpg. wt. 16 lbs. **\$14.50**

No. 85,122 Fits our 4 1/4". Shpg. wt. 16 lbs. **\$13.50**

Set of three toes only. **No. 70,693 \$9.95 Ppd.**

NORTON'S STAR ATLAS . . . Norton & Inglis

This valuable reference book contains 9,000 stars, nebulae and star clusters, lists of objects suitable for viewing with small telescopes, and 18 intricate star charts. Also has information on the sun, moon and planets; new moon map in color with 300 named features; and a list of astronomical definitions. Hardbound, 90 pages. (8 1/2" x 11")

No. 9234 \$6.50 Postpaid

CAMERA BODY FOR PHOTOGRAPHING STARS AND PLANETS

This 35mm single lens reflex camera body is the best and most practical one available for amateur astrophotography. Ideally suited for prime-focus use with Edmund reflector and refractor telescopes as well as most other makes. "T"-compatible adapter locks securely into bayonet-type lens mount of camera body; second adapter, manufactured by us especially for this application, screws into first and has 1 1/4" O.D. for direct hook-up to all standard telescope eyepiece holders. Both adapters included.

Rugged and simple to operate, includes the features most wanted by astro-photographers; focal plane shutter; waistlevel finder with conventional ground-glass focusing; fully-removable back; selftimer. One knob winds film, sets shutter speeds and resets mirror. Shutter speeds are: bulb, 1, 1/2, 1/5, 1/10, 1/25, 1/50, 1/75, 1/100, 1/200, 1/500 and 1/1000 second; all in-between speeds may be set. Unique design of shutter release allows maximum sharpness through vibration-free exposure. By applying pressure slowly to release, mirror and shutter can be activated in two separate and distinct motions. Vibrations can actually be made to leave the camera before shutter goes off! An excellent camera for general picture taking too—full line of lenses and accessories available through regular photographic sources. Includes X and F flash synchronization and direct optical viewfinder for working under extremely poor light.

No. 70,857 \$79.00 Ppd.

For rigid mounting, use Camera Holder No. 70,162 above. Order Book No. 9078 listed below.

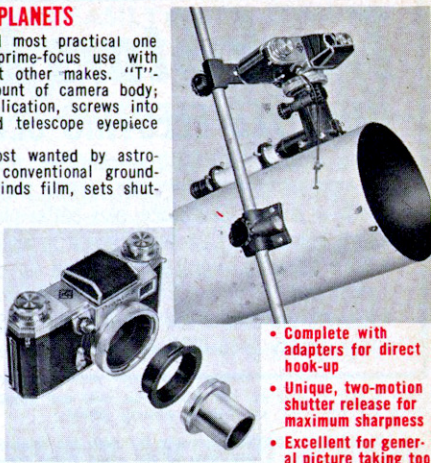

- Complete with adapters for direct hook-up
- Unique, two-motion shutter release for maximum sharpness
- Excellent for general picture taking too

OBSERVING THE SUN

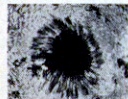

Simplest and safest method is Sun Projection, using the equipment on this page. For direct observation, use a Herschel Wedge with a sun filter over the eyepiece, for protection. Order our booklet, "Observing the Sun" for further information.

No. 9056 Only 15¢ Postpaid

Mounted Herschel Wedge. Fits holder No. 50,077 used on 4 1/4", 6" reflectors. 5" x 3 1/2" rod is long enough for 4 1/4", 6" & 8" mirrors. Wedge angle —10°. Critical surface flat to 1/4 wave. 40x55mm.

No. 30,266 \$5.50 Ppd.

Unmounted Wedge. **No. 30,265 \$3.50 Ppd.**

Sun Filters. Protect the eyes. Light transmission: visible .009%, ultraviolet none, infrared .0190%. **No. 2729 (1 1/4" round x 3mm thick) \$1.50 Ppd.**

"PHOTOGRAPHY WITH YOUR TELESCOPE"

By Sam Brown

36-page book shows in easy text and clear illustrations how to take exciting photos of moon, planets, stars; long distance shots of birds, animals, etc. through the "big eye" of your telescope. Above photo of telephone pole was taken through a 4 1/4" reflector 300 yards away. Regular telephoto systems average only 2X to 3X. With your telescope you choose the power! Book includes: The Refractor and Reflector as Cameras, Using Photographic Optics, Mounting Camera, Auxiliary Lenses, etc.; plus tables on spacing, image sizes, fields and more. **No. 9078 Only 75¢ Ppd.**

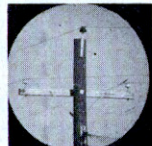

New! Edmund's 11" x 17" Universal Star Maps

These fill the need that existed for large, inexpensive star maps that are more complete than our Rotating Star & Planet Finder. Set of 8 includes 2 Circum Polar maps of North and South Hemispheres (50° to 60° latitude) and 6 Equatorial maps (—60° to +60°) which tie in with Circum Polar maps. Set covers the Messier Objects and stars down to the 5th magnitude, which can be seen with the naked eye. Maps are printed on eight 11" x 17" sheets and are suitable for constellation study and adding your own notations. 8 maps in folder. See below for quantity prices. **No. P-9099 \$1.00 Ppd.**

Pkg. of 25 **No. P-71,113 \$20.00 Ppd.**
Pkg. of 100 **No. P-85,153 \$60.00 T.C.C.***

*Shpg. wt. approx. 32 lbs.

CAMERA HOLDER & SUN SCREEN FOR SCOPE

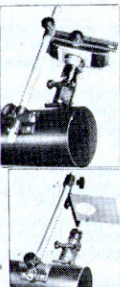

With this set you utilize your telescope and its eyepieces plus your own camera to take exciting photos. The set includes a bracket which permanently bolts to the telescope. Whenever you wish to take pictures attach the rod and camera holder. The latter, adjustable on the rod, has a standard 1/4", 20-thread fitting. This screws into the tripod receptacle on your camera. Light weight aluminum with black wrinkle finish. Rod is 28 3/4" long. Sun projection screen included attaches to the rod. Place it behind the eyepiece, point scope at sun and move screen to focus. See sunspots projected clearly on screen.

No. 70,162 \$9.95 Ppd.

CAMERA ADAPTERS FOR TELESCOPES

(A) Use your 35mm S.L.R. camera for prime focus astrophotography. All you need is one of our aluminum camera-to-telescope adapters and a "T" adapter (listed below under "B"). Adapters' metric thread connects one end to "T" adapter which, in turn, connects to camera. The 1 1/8" long parallel shank on the other end fits inside telescope eyepiece tube. Black anodized interior prevents undesirable reflections.

1 1/4" O.D. Adapter for standard American telescopes **No. 40,975 \$6.50 Ppd.**

0.960" O.D. Adapter for Japanese telescopes **No. 41,121 \$6.50 Ppd.**

(B) Camera Adapters. "T" compatible. Connect SLR cameras as listed to Telescope Adapters above.

Camera	Praktika	Exakta	Miranda	Minolta	Nikon
Stock No.	40,960	40,959	40,958	40,957	40,956
Price/Ppd.	\$3.00	\$5.00	\$3.00	\$5.00	\$5.75

STAR GAZING WITH TELESCOPE AND CAMERA

By George T. Keene, noted lecturer on astronomy. Has dozens of photos and drawings plus how to find celestial objects, how to select telescopes and binoculars, how to make a reflector, etc. Written for beginner with box camera, or owner of large motor driven telescope. Paperbound, 4 7/8" x 7 9/4" 128 pp. **No. 9350 \$1.95 Ppd.**

EDMUND MINI-MOON—AN EXACT REPLICA IN RELIEF

This 12" diam. bluish-gray, three-dimensional model is an exact replica in relief as seen through telescope. Study various features of the moon... from the 2-million square mile Ocean of Storms to the 29-mile crater Aristarchus. Proper surface size and distance relationships. Principal peaks rise 1/8". Valuable teaching aid. With proper rotation and lighting, you can show moon phases. Molded of tough, washable plastic in three colors. Can be marked without damage. Reverse side is blank. Use it to indicate information of latest moon photos! Slight ridge at equator line gives strength. Aluminum base. Wt. approx. 3/4 lb. **No. 70,515 \$12.50 Ppd.**



BIG 48 1/2" x 53 1/2" 3-D OFFICIAL MOON MAP

The most detailed map of the moon ever printed. Over 200 names of oceans, seas, mountains, craters, peaks, etc. Separate index to every physical feature named. Gives elevation of mountains and depth of craters. Special four-color printing for 3-D effect. **No. 9380 \$1.95 Ppd.**

35" x 46" PHOTO-REPRODUCED MOON MAP

Edmund Scientific Co. strongly recommends this big photographic reproduction of the full moon. This very helpful aid is printed in black and white and has all named lunar formations clearly marked. Gives a complete index to their locations and includes other valuable lunar information. **No. 9297 95¢ Ppd.**

helpful aid is printed in black and white and has all named lunar formations clearly marked. Gives a complete index to their locations and includes other valuable lunar information. **No. 9297 95¢ Ppd.**

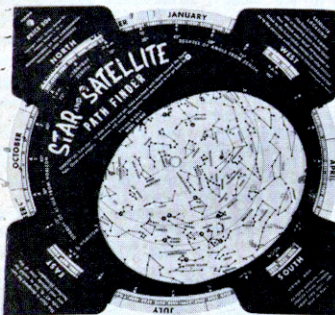

ROTATING STAR AND PLANET FINDER

A "roadmap" of the heavens! This rotating chart shows over 500 stars in the heavens and their relationships to each other at any selected day and hour. By simply turning the disc until date and time are set, the positions of the stars on the chart will match the positions of the stars in the sky. A marvelous aid to observing the great parade in the heavens. Reverse side contains astronomical facts. Free with your Chart is a valuable illustrated booklet, "Star Paths" which shows you how to use it most effectively. Includes easily understood, simplified drawings of celestial sphere, key points on meridian, time correction tables, how to find planets, etc. "Star Paths" booklet has 16 pages, 4"x5 1/4". Complete set, Chart and "Star Paths." **No. 9227 50¢ Ppd.**

Pkg. of 25 **No. P-70,156 \$10.00 Ppd.**
Pkg. of 100 **No. P-80,063 \$30.00 Ppd.**

Make Your Own Star Charts. Cut and fold accurate 11" x 17" star maps into working star charts. Package of 25. **No. P-9061 \$1.00 Ppd.**

See New 11" x 17" Star Maps, page 138

ACCURATE STAR FINDER GIVES SIDEREAL TIME

Tops for casual observer or serious amateur with circle-equipped telescope. This very good planisphere quickly pinpoints sky objects not visible to the naked eye. Simply set your longitude, standard time, and date to read sidereal time—principal aid for exploring the heavens. Accurate to within 2 minutes! Also shows the stars in the heavens at your location and their relation to each other at any selected day and hour; determines longitude; gives solar time directly from the stars; illustrates motion.

Rigid plastic (10" x 11 3/4") won't warp, markings won't rub off. Includes 90 page (8 1/2" x 11") book "Find the Stars" with instructions, 22 sky maps, and information on over 250 celestial objects. **No. 70,815 \$9.95 Ppd.**

6 GIANT EARTH AND SPACE MAPS—Only \$2.25

Attractive wall decoration for child's room, recreation room, den or study. Extremely educational.

1. Outer Space, 35"x48". Full color. Bold presentation showing the relationships of our space neighbors.
2. Solar System, 34"x46". Yellow and black. Includes dramatic photos plus 13"-diameter detailed moon map.
3. World Star Chart (illustrated), 29"x41". Blue and white. Brings real meaning to youth's studies.
4. United States, 35"x49". Full color.
5. World, 35"x48". Full color.
6. 5,000-Year History of Man — 3,000 B. C. to present, 35"x48". Full color. Lists important historic events and the date of their occurrence. Illustrates costumes, weapons, tools, inventions, transportation, art and architecture of each period.

Complete set. **No. P-9366 \$2.25 Ppd.**



DRAMATIC ASTRO MURALS 2x3 FT. YOUR CHOICE \$6.00 POSTPAID

These 2 ft. x 3 ft. murals are exact, black and white reproductions of famous sky phenomena. Their wealth of detail is amazing. Prints are reproduced on fine paper by the Colotype process... no screen to spoil the photo effect. Frame several to give your room an astronomical atmosphere. Ideal decorations for home, school or institutions. Astro murals are endorsed by many leading, professional astronomers.

(A) Moon, Last Quarter, No. 70,243; (B) Great Nebula in Orion, No. 70,244; (C) Spiral Nebula in Triangulum, No. 70,245; (D) Great Nebula in Andromeda, No. 70,246; (E) Southern Sector of Moon, No. 70,248; (F) Saturn, No. 70,247; (G) Solar Prominence, No. 70,249; (H) Spiral Nebula in Canes Venatici, No. 70,251; (I) Spiral Nebula in Andromeda Edge on View, No. 70,250; Moon, 14 Days (NOT ILLUSTRATED), No. 70,252.

Any one (please specify). **\$6.00 ea., Ppd.**

LARGE, FULL COLOR ASTRO MURALS

Big 2-ft. x 3-ft. prints from history making photographs. Distinguished decoration, faithful screenless reproduction.

Veil Nebula in Cygnus. Exposure 2 hrs., 48" Schmidt telescope. Shipped in tube. **No. 70,741 \$15.00 Ppd.**

Crab Nebula in Taurus. Exposure 4 hours, 20" Hale. In tube. **No. 70,740 \$15.00 Ppd.**

UNIVERSAL PLANETARIUM... TEACHING AID

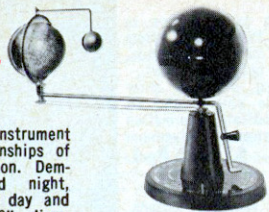

Versatile, compact instrument for teaching relationships of sun, earth, and moon. Demonstrates day and night, seasons, lengths of day and phases of moon. 6" diam. sun, earth and moon are supported on plastic base. Hand operated chain drive orients the earth. 12" x 8" x 18". Illustrated handbook.

No. 70,415 \$29.95 Ppd.

Universe Mobile Demonstrates Solar System

Huge, 9 sq. ft. mobile attractively shows and names 9 planets, moving around the sun, nebulae, galaxies, Milky Way, Halley's Comet, star clusters, etc. Astronomically accurate, it helps children understand outer space. Based on Palomar Observatory color photos. Heavy, washable, plastic-coated fibre-board in color. Includes easy-assembly instructions, adhesive ceiling-hanger and 8 page booklet about universe.

No. 70,979 \$2.00 Ppd.

FORTY 35MM SLIDES OF CONSTELLATIONS

An excellent introduction to 46 Northern Hemisphere constellations. Slides include the fainter background stars usually omitted from plotted star maps. Five seasonal and regional star map slides give a preview of the constellations which follow in order. One, for example, is entitled "Constellations of a Summer Evening" and presents the sky as it would appear to an observer facing south at 9 o'clock on the evening of Aug. 6. Approximate times on dates other than this can easily be calculated.

No. P-60,167 \$16.00 Ppd.

TWENTY-NINE 35MM SLIDES OF MOON

This highly informative series of black and white slides shows many interesting features of the moon's surface. Included are the full moon taken through Mt. Wilson's 100" reflector; Clavius, the largest and clearest Moon crater, photographed through the 200" reflector at Mt. Palomar. Recommended for students from the 6th grade up with some previous subject knowledge. Leaflet included gives complete descriptions of each of the slides... your presentation is already prepared.

No. P-60,348 \$5.00 Ppd.

50-PAGE ATLAS OF SPACE

By U. S. Naval Institute. 23 photos, 22 diagrams, moon map.

No. 9347 \$1.25 Postpaid

"STAR MAPS FOR BEGINNERS," Levitt & Marshall

This popular book is one of the best available for beginning star-gazers. Twelve maps, one for each month, divide the sky into quadrants. 47 pages (8 1/2" x 11").

No. 9359 \$1.75 Ppd.

"ALL ABOUT TELESCOPES" by Sam Brown

The best illustrated and most easily understood book about telescopes and astronomy. Whether you are a beginner or an advanced amateur, you need this book. Now available in both perfect binding and special case-bound library editions. See Nos. 9094 and 9385, page 142.

NOVA HOME PLANETARIUM—BRINGS OUTER SPACE INDOORS

• Full Line of Accessories Provides hours of exciting study for boys and girls by projecting over 60 constellations and hundreds of stars on the wall and ceiling. Two simple adjustments take you into any month of the year at any place in the Northern Hemisphere. Rotate the sphere by hand to demonstrate daily movement of the stars. 14" high plastic Planetarium stands on 7" x 7" base. Operates on standard house current. Built-in rheostat controls brightness. Includes these accessories: arrow pointer; projector with 12 slides of constellations that can be silhouetted over stars; 2 blank slides; projector to simulate 6 solar and lunar eclipses; 16mm film strip projector with 4 shows (over 150 pictures) including "Trip to the Moon"; power pack with rheostat; and instructions.



No. 70,679 \$30.00 Ppd.

125 STARS THAT GLOW IN THE DARK

Transform your room into a realistic night sky with these star decals made of safe, non-radioactive phosphorus. Place decals on walls and ceiling to set up authentic space scenes. Use in child's room to allay fears of the dark. Decals glow brightly after exposure to bright light. Set contains 125 decals in assorted sizes up to 1" in diam.; plus the moon, Saturn and a comet. All on two, 6 1/2" x 9 1/2" transfer sheets. Simply moisten and slide off. Includes instructions and an accurate star chart for realistic placement of constellations.

No. 9298 \$1.00 Ppd.

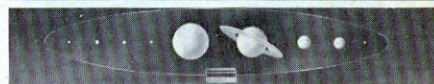

SOLAR PLANET DISPLAY BUILT TO SCALE

Unique decorative accessory and conversation piece. Shows relative size of all 9 planets in their order from the Sun. Planets scaled 1" to 60,000 miles, mounted in clear plastic ellipse scaled to Sun's diameter. Fine classroom visual aid. Measures 14 3/8" x 2 3/4" including base. Easy assembly instructions.

No. 70,873 \$5.00 Ppd.

CELESTIAL OBJECTS FOR COMMON TELESCOPES

Two volumes by T. W. Webb, revised by Margaret W. Mayall. Shows you what to look for, how and where. Volume 1 covers the entire solar system with the exception of Pluto and the asteroids; many observing hints included. Volume 2, "The Stars" is the largest and finest collection of data available about celestial objects for moderate sized telescopes. Volume 1 has 27 illustrations, 255 pages. Volume 2, 19 illustrations, 351 pages. Paperbacks, 5 1/2" x 8".

No. 9349 \$4.50 Ppd.

DISCOVER THE STARS... Johnson & Adler

Paper bound, 146 pages. Beginner's guide to astronomy. Radio astronomy, navigation, solar energy, simple make-your-own instruments. Photographs and diagrams.

No. 9225 \$1.00 Postpaid

"NEW HANDBOOK OF THE HEAVENS"

Leads the way to an understanding and enjoyment of astronomy. Explains the constellations, nebulae, sun, planets, rainbows, and other cosmic phenomena. Paper-bound, 272 pages plus 28-page photo insert. (4 1/4" x 6 7/8")

No. 9204 75c Ppd.

ASTRONOMY MADE SIMPLE... M. H. Degani

192 pages (8" x 10 3/4").

No. 9229 \$1.95 Ppd.

SPILHAUS SPACE CLOCK—WORLD'S MOST INFORMATIVE CLOCK

CREATED BY DR. ATHELSTAN SPILHAUS

Dr. Spilhaus, one of America's leading scientists, took 5 years to develop this space-age astronomical clock. Large top dial has 5 transparent overlay discs. Four, rotating independently, combine with the fixed disc to capture the depth of the night sky and automatically show you 19 up-to-the-minute pieces of information related to time, the moon, sun, stars and tides.

Read Top 8 5/8" Dial for...

1. The horizon and the visible heavens
2. The sun's position in the sky
3. Moon's position
4. Position of the stars
5. Relative positions of sun, moon & stars
6. Day, month, year. A perpetual calendar
7. Meridian solar-time of sun, moon & stars
8. Sidereal or star time (used with tables)
9. Current phase of the moon
10. Time of daily sunrise and sunset
11. Mean time of moonrise and moonset
12. Mean time of star-rise and star-set
13. Current time of high or low tide
14. Current stage of the tide
15. Mean star time

Lower Left 4" Dial shows...

16. Ordinary or zone time

Lower Right 4" Dial shows...

17. 24-hour time
18. Universal or Greenwich Mean Time
19. Time in major cities of USA and world (L.M.T.).

EXPERTLY ENGINEERED. Easily set for any location in the Northern Hemisphere. No periodic adjustments are necessary but a simple turning of the calendar dial on Feb. 29th each leap year. Original starting is very easy. Adjustments, if desired, do not interfere with other settings... all adjustment knobs are behind magnetically-held, matching back panel.

The Space Clock's solid cherry case and fruitwood finish blends with any decor. Brush finished brass top

HOME SCHOOL OFFICE STORE LIBRARY CLUBROOM

Illuminated Dials



A SPACE AGE INFORMATION CENTER UNIQUE GIFT, PRESENTATION OR AWARD OUTSTANDING SCHOOL TEACHING AID

1 YEAR GUARANTEE

The Spilhaus Space Clock is guaranteed to be free from defects in materials and workmanship for 1 year.

is lacquered for protection. Domed crystals, soft 3-point illumination, push-button control. Powered by 115-volt, 60-cycle, A.C. clock motor (other voltages and cycles for foreign countries are available on special order).

Clock stands 15 3/8" high; base is 11 3/4" x 5" wide. "Lots of Time", a 32-page easily understood instruction manual, is included. Total shpg. wt. 13 pounds.

No. 1202 \$250.00 Trans. Chg. Coll.

EASY-TO-FOLLOW "BUILD YOUR OWN" TELESCOPE BOOKS

MAKING YOUR OWN TELESCOPE... Thompson

An old standard for amateurs and a valuable addition to your telescope "know-how." Step-by-step coverage of mirror grinding, pitch lap, polishing, testing, correcting, the paraboloid, the diagonal, the finder, eyepieces, mounting, aluminizing, setting circles, optical principles, secondary reflections, etc. Cloth bound. 211 pages (5 1/4" x 8 3/4") with 98 illus.

No. 9203 \$4.00 Ppd.

HOW TO MAKE A TELESCOPE... Jean Texereau

Written by the President of the Committee on Instruments of the Astronomical Society of France. Covers: basic principles, making the mirror, the plane diagonal mirror, the eyepiece, mechanical structure, the altazimuth mounting, accessories, mirror coating, adjustments, the telescope in use, photography with your telescope. Cloth-bound volume sold for \$4.00. Paperback. 258 pages (4 1/8" x 7 1/8") with 86 diagrams and illustrations.

No. 9355 \$1.45 Postpaid

NEW BOOK "TELESCOPES FOR SKYGAZING"

How to choose, test, and use a telescope, how to assemble one yourself, what sky objects to set your sights on; plus astrophotography and binoculars in astronomy. By H. E. Paul. Hardbound, 160 pages (6" x 9") with over 225 illustrations.

No. 9375 \$4.95 Postpaid

See Sam Brown's "All About Telescopes", page 142

Albert G. Ingalls, who formerly conducted the Amateur Telescope Makers column in "Scientific American," compiled this series of 3 clothbound books. Each chapter is written by an expert. Includes a symposium of articles on every subject connected with amateur telescope making.

AMATEUR TELESCOPE MAKING, Book I

Complete information on astronomical telescope making including grinding your own mirror, testing and figuring.

Also includes articles on mountings, eyepieces, motor drives, observing, spectroscopes, celestial photography, etc.

No. 9208 \$5.00 Postpaid

AMATEUR TELESCOPE MAKING (Advanced), Book II

More advanced information on construction of optical instruments, testing, small lens making, refracting telescope objectives and mounting, drives for larger scopes, Springfield mounting and many other subjects are covered. Includes a total of 125 pages on observing.

No. 9209 \$6.00 Postpaid

AMATEUR TELESCOPE MAKING, Book III

The final book of the series. Covers spectrographs, diffraction gratings, Null test, optical flats, lens production, Barlow lens, lenses for astrophotography, Schmidt principle, etc.

No. 9224 \$7.00 Postpaid

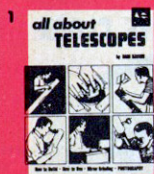

1. "ALL ABOUT TELESCOPES"

by Sam Brown

The Best Illustrated And Most Easily Understood Book About Telescopes & Astronomy Whether you're a beginner looking for information and guidance about the type of telescope you should build or buy; or an advanced amateur seeking help in ray tracing or a formula to work out object-image sizes... YOU NEED THIS BOOK! Written in Sam Brown's down-to-earth, easy-to-understand style, this informative book is one half text with the other half consisting of clear, how-to-do-it illustrations. It contains sections from Sam's previous books on telescopes and astronomy including: "Telescopes You Can Build," "How To Use Your Telescope," "Homebuilt Telescopes," "Telescope Optics," "Photography With Your Telescope," and "Time And Astronomy"; plus completely new material covering "Getting Acquainted With The Telescope," "Observing The Sky Show," "Collimation And Adjustment," index, etc. Available in both paper cover binding and case-bound library edition. Free library index card on request.

Paper Bound, 8 1/2" x 11", 192 pages plus covers

No. 9094 \$3.00 Ppd.

Special Case-Bound Library Edition, 8 7/8" x 11 1/4"

No. 9385 \$6.75 Ppd.



2. "TELESCOPE OPTICS"

by Sam Brown

Here at last is the answer to hundreds of amateurs' requests... a graphically clear book on optical design of telescopes. Not a Ph.D. dissertation, but an interesting coverage of focal length, image-object problems, graphical ray tracing, home-made eyepieces and objectives (mirrors and lenses) and more. Tables and diagrams make your calculating crystal clear. Paperbound, 32 pages (8 1/2" x 11").

No. 9074 60c Ppd.

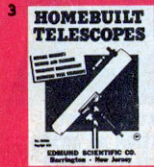

3. "HOMEBUILT TELESCOPES"

by Sam Brown

Shows you how to make a reflecting telescope mirror with surface accuracy to a millionth of an inch! It will save you as much as \$40.00 on the mirror alone, based on the cost of a finished 6" mirror, 1/4-wave quality.

Detailed, illustrated instructions on: Grinding stand, grinding stroke, forming the curve, chamfering, testing the curve, smoothing the curve, fine grinding, finding the focal length, reflection testing, polishing, correcting techniques, parabolizing, etc. Also mechanical construction of the telescope. 36 pages (8 1/2" x 11").

No. 9066 75c Ppd.



4. "TELESCOPES YOU CAN BUILD"

by Sam Brown

Written in language that everyone can understand, it gives step-by-step building instructions covering 27 Telescopes and 10 Accessories. Includes detailed, illustrated instructions for building: 8X Sky Starter, 33X Prismatic Scope, 8X to 20X Variable Power Telescope. Also detailed, illustrated instructions for 3", 4 1/4", 6" Reflectors, 3" Refractor, Low-Cost Refractors, 30X Baby Refractor. 36 pages. (8 1/2" x 11").

No. 9065 Only 75c Ppd.

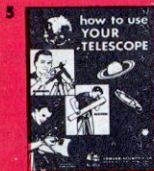

5. "HOW TO USE YOUR TELESCOPE"

by Sam Brown

If you now own, or if you plan to buy a telescope, here's a down to earth introduction to astronomical telescopes and the stars. Ideal for the beginner and full of useful information for any amateur.

LEARN ABOUT: Observing the planets • Observing the sun • Comparing the planets • Splitting doubles • Finding sky objects • Telescope arithmetic • Astronomical photography with your telescope • Sky sweeping • Dawes Limit.

FULL INFORMATION ON: Telescope power • Field of view • Selecting your telescope • What eyepiece is best • Light gathering power • Collimation and adjustment • Telescope performance... what to expect • Equatorial mounts... how to use • Barlow lenses and power boosters. 32 pages. (8 1/2" x 11").

No. 9055 60c Ppd.

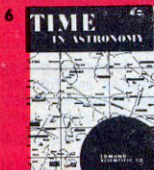

6. "TIME IN ASTRONOMY"

by Sam Brown

"The yardstick used to measure time is the period it takes the earth to make one complete rotation." In this enlarged edition, Sam Brown describes 3 kinds of Solar Time, Mean to Standard, Standard to G.M.T., Sidereal Time, Time Around the World, etc. Text covers position of a star, adjusting polar axis, finding sky objects using "star hopping" system, S.H.A. and R.A. systems. An equatorial star chart is included plus list of brightest stars, selected sky objects and numerous tables. Illustrated, 36 pages (8 1/2" x 11").

No. 9054 75c Ppd.



7. "MOUNTING YOUR TELESCOPE"

by Sam Brown

Discusses various types of telescope mounts in a most easy-to-read fashion. Tells you how to mount reflectors and refractors. You'll find this book a treasure house of information for building or purchasing a telescope mount. Completely illustrated. You can visually compare the different styles of mounts, their components and accessories. Learn about equatorial and altazimuth mounts, tripods vs. pedestals, setting circles, clock drives, slow motion controls, homemade counterweights, cradles, the "floating" clock, etc. Many useful hints for easy and sturdy construction. 36 pages including paper covers. (8 1/2" x 11").

No. 9082 75c Ppd.

4-DIGIT TALLY COUNTER FOR HAND OR DESK USE



Hold in hand or place it in included base for desk use. Whatever you have to tally—people, cars, goods, inquiries, calls—this rugged counter will handle the job. Registers up to 9,999 in easy-to-read white numerals etched in a black background. Equipped with chrome-plated plunger and reset knob. Sturdy, built-in chain loops over 2 fingers so you can release counter and handle other objects. Just swing it back and it's ready for use. 3 1/8" long x 1 5/8" wide (incl. reset knob). When placed in gray plastic base, it stands approx. 3 1/2" high.

No. 41,130 \$8.50 Ppd.

MECHANICAL AND ELECTRONIC KITS

The perfect gifts for youngsters age 9 and up. Develops skills and interests through construction of fascinating, working projects. Have fun, learn by doing.



MECHANICAL EDUCATIONAL KIT

Build over 40 operating projects such as mobile cranes, tractors, pile-drivers, clocks, water and air pumps, etc. All models are transparent so you can see mechanism in operation. Kit contains over 600 indestructible, precision-made plastic components packed in compartmented wooden box. 136-page illus. manual incl.

No. 70,902 \$39.95 Ppd.

DELUXE ELECTRONICS KIT

With this kit you can build 23 different operating projects including radio receiver, flashing beacon, electronic organ, burglar alarm, etc. No soldering or tools required. Templates provided for each circuit. Peg board construction enables easy stripping of one project to build another. Instructions included.

No. 70,904 \$27.95 Ppd.

STARTER ELECTRONICS KIT

Similar to above; parts to build 8 different projects.

No. 70,903 \$17.95 Ppd.

QUARTZ IODINE LAMP... 10,000 Lumens, 425W

Use indoors or out for spots, floodlamps, general use. These are used (removed from equipment), but still have plenty of life. Bargain priced... cost \$12.00 now. Originally rated 400-hr. life. Quartz envelope doesn't blacken; self-cleaning iodine cycle assures over 95% of initial brightness right up to burn-out. Recessed single contacts for use with socket below. Operates in horizontal position only. Color 3200°K, internally fused, for 120 volts. 3/8" diam. x 4 5/8" long. With instructions.

Quartz Iodine Lamp No. 60,729 \$2.95 Ppd.

Socket For Above No. 60,730 \$1.50 Ppd.

'THE COLOR TREE' & 19 DEMONSTRATION SLIDES



Color, a vital factor in our lives, is especially vibrant in all aspects of art, advertising, decorating, and light shows (see MusicVision, pages 12-16), but what's the science behind it all? See and learn about simultaneous contrast, negative after-image, spots before your eyes, and many others in "The Color Tree." This 48-page, 5" x 6" booklet, was written for the layman and artist-designers by top-flighted color scientists. The text is amplified with 29 colored illustrations. The 19, 35mm color slides tie in with the text for demonstration of color effects to larger groups.

Booklet & Slides No. 60,745 \$10.50 Ppd.

"OPTIX"... THE WORLD OF LENTICULAR OPTICS



• First Book That Reveals The Secrets Of 3D Printing And Photography

Until now, there has been practically no published technical information on the very interesting and profitable subject of lenticular optics. This book, written especially for Edmund Scientific Co., by S. Z. Klein, an expert on lenticular optics, reveals secrets known only to a select few in the trade. You'll learn about 3-D camera systems and photography, special printing methods, lenticular lens manufacture and technology, lenticular printing, optical art creations, and much more. We also include a lenticular screen which you'll use on some of the book's illustrations to demonstrate the amazing effects of tone change, motion, and dimension. The use of lenticular optics is rapidly expanding in photography, art, education, industry, advertising, etc. Our 3-D Post Cards (see below) and Psychedelic Art Plaques and Jewelry (p. 44) are products of this process. "Optix", 20 pages, paper covers, 8 1/2" x 11". (Available about Nov. 1, 1968)

No. 9097 \$3.50 Ppd.

LENTICULAR ART KIT

Make your own lenticular works of art and demonstrate lenticular effects. It's easy and fun. Kit contains: one 7" x 7" lenticular screen (62 lines per inch); two 7" x 7" special patterns... Hypnogyro, Starspin, and two 5" x 5" Kaleidoscopic & Telstar patterns, with instructions.

No. 60,747 \$3.00 Ppd.

Larger Lenticular Screens, See Page 20.



SPACE AGE 3D POSTCARDS

Full color postcards with outer space themes. Give almost unbelievable 3D picture depth from a flat surface. Mail them to your friends or decorate your room. 2 sizes and scenes available. The 4 1/8" x 5 5/8" size shows astronauts nearing an asteroid space station. The 6" x 8 5/8" size shows an astronaut taking a space walk using rockets and a life line.

Pkg. of 2, 1 of each. No. 9383 \$1.50 Ppd.

Pkg. of 6, Space Walk, 6" x 8 5/8". No. 9386 \$4.00 Ppd.

Pkg. of 12, Space Station, 4 1/8" x 5 5/8". No. 9384 \$4.50 Ppd.

SALE! ALNICO MAGNETS

10 Powerful Magnets for Only \$2

Each of these small, 2 1/2" diam. x 5/8" high magnets has a pull of 18 oz. Perfect for home use, experiments, or just plain fun for the kids.

Pkg. of 10

No. P-60,577 \$2.00 Ppd.

Pkg. of 100

No. P-70,831 \$16.00 Ppd.

Write for special prices for 1000 or more.

SURPLUS, HIGH-QUALITY, CAMERA SHUTTER

Commercial surplus, bargain priced. Has iris openings (f/stops) of 4.5, 5.6, 8, 11, 16, and 22. Speeds are 1/25, 1/75, 1/200, and Bulb. Manual cocking with cable release socket and M flash synchronization. Front threaded opening 22mm diam. Rear threaded flange 25mm diam.

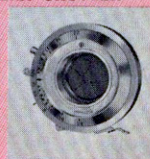

No. 41,172 \$5.95 Ppd.